

Keep safe



LIFE SCIENCE WATER APPARATUS

Leveluk *SD501*
PLATINUM

- English
- Deutsch
- Français
- Italiano
- Español



5 Languages

Continuous ionized KANGEN and strong acidic water generator

Operation Manual

Household Use

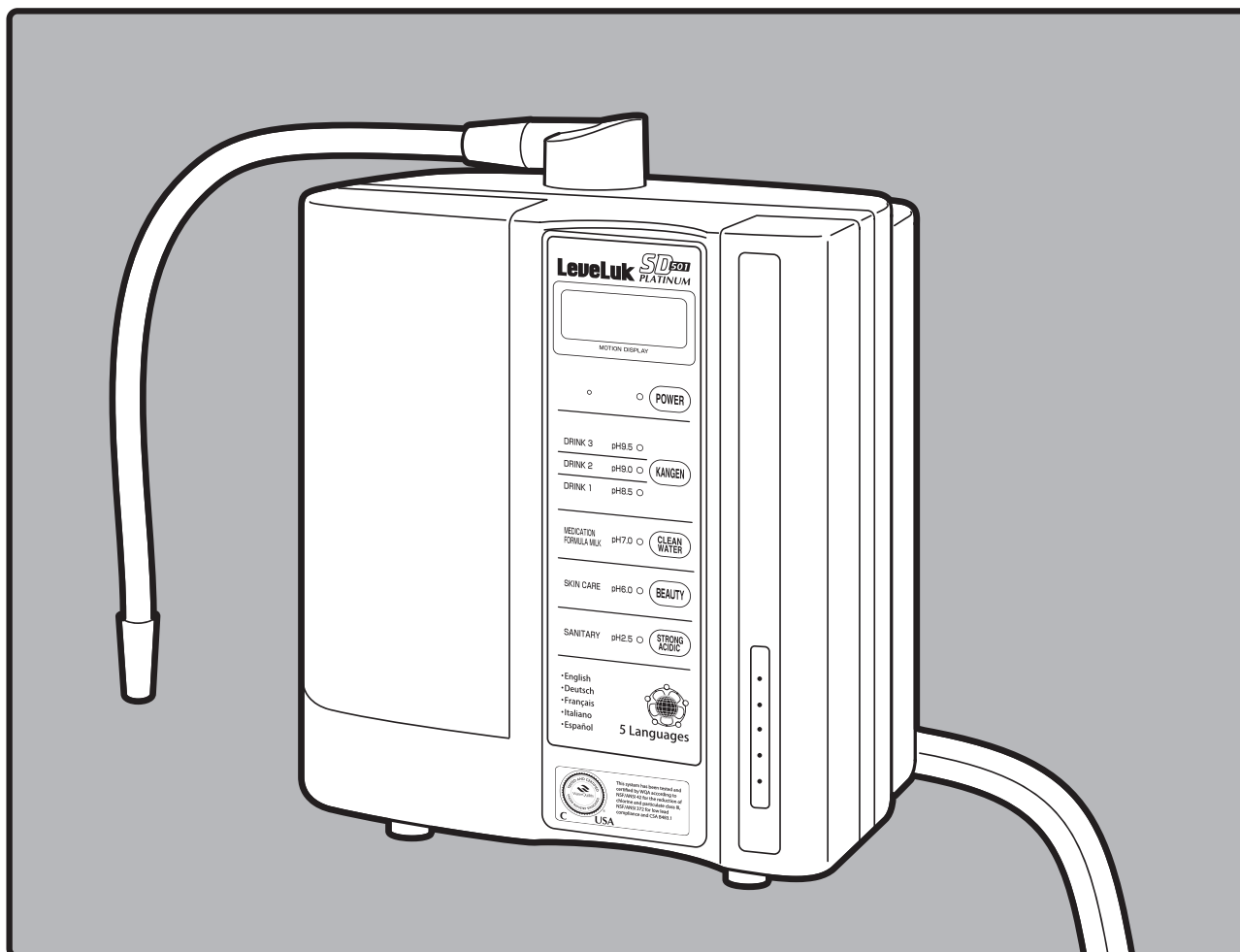

Thank you very much for purchasing our product.

- Please read this manual carefully and thoroughly before operation.
- This unit must be used correctly, according to the manufactures instructions.
- Please keep this manual in a safe place for future reference.

Replacement filter of this product : HG-N

Los Angeles :

4115 Spencer Street Torrance, CA 90503-2419
TEL. +1-310-542-7700 FAX. +1-310-542-1700

New York :

3636 33rd street Suite 101 Long Island City NY 11106
TEL. +1-718-784-2110 FAX. +1-718-784-2103

Chicago :

1154 S. Elmhurst Rd. Mount Prospect, IL 60056-4241
TEL. +1-847-430-4013 FAX. +1-847-437-8201

Honolulu :

Ala Moana Pacific Center, Suite 711 1585 Kapiolani Boulevard
Honolulu, Hawaii 96814
TEL. +1-808-949-5300 FAX. +1-808-949-5336

Texas :

545 Rowlett Road Suite A Garland, TX 75043
TEL. +1-972-316-7985 FAX. +1-310-531-7111

Seattle :

18920 28th Ave. W Suite 105 Lynnwood, WA 98036
TEL. +1-425-640-2222 FAX. +1-425-672-8946

Orlando :

8803 Futures Drive, Unit 01 Orlando, FL 32819
TEL. +1-407-601-5963 FAX. +1-407-630-6081

Burnaby :

101-7460 Edmonds Street Burnaby BC V3N 1B2
TEL. +1-604-214-0065 FAX. +1-604-214-0067

Toronto :

Unit 23 - 156 Duncan Mill Rd North York, ON,
M3B 3N2, Canada
TEL. +1-905-507-1200 FAX. +1-416-445-6594

Mexico :

Av Vasconcelos 345 col Santa Engracia
San Pedro Garza Garcia Nuevo Leon, Mexico
TEL. +52-81-8242-5500 FAX. +52-81-8242-5549

Brazil :

Rua Joao Dos Santos,532 Jardim Santa Rosalia,
Sorocaba, Sao Paulo 18090-040, Brazil
TEL. +55-15-3034-4132 FAX. +55-15-3034-4100

Germany :

Charlottenstr. 73 40210 Düsseldorf, Germany
TEL. +49-211-936570-00 FAX. +49-211-936570-27

France :

8-10 avenue ledru-Rollin 3rd floor 75012 Paris France
TEL. +33 (0) 1 47 07 55 65 FAX. +33 (0) 1 83 71 17 06

Italy :

Via Marco Aurelio, 35 00184, Rome, Italy
TEL. +39-6-3330-670 FAX. +39-6-3321-9505

Australia :

Suite 15, 33 Waterloo Road, Macquarie Park NSW 2113, Australia
TEL. +61-2-9878-1100 FAX. +61-2-9878-1200

Russia :

Letnikovskaya Str. 10 Bld. 4, Floor 1 115114, Moscow, Russia
TEL. +7-495-988-02-05 FAX. +7-495-988-02-06

Romania :

68-70 6th floor 500397 Braşov, Romania
TEL. +40-374028779

Portugal :

Av. de França, nº 735 4250 214 Porto, Portugal
TEL. +351-22-8305464

Hong Kong :

Unit 1615-17 16th Floor Mira Place Tower A 132 Nathan Rd.,
Tsim Sha Tsui Kowloon, Hong Kong
TEL. +852-2154-0077 FAX. +852-2154-0027

Taiwan :

Asia World Bldg. 12B., No.337, Sec. 3, Nanjing E. Rd., Songshan Dist.,
Taipei City 105, Taiwan, R.O.C
TEL. +886-2-2713-2936 FAX. +886-2-2713-2938

Philippines :

Unit 3-4, 16th Floor RCBC Savings Bank Corporate Center
Bonifacio Global City Taguig City, Metro Manila
TEL. +63-2-519-5508 FAX. +63-2-519-1923

Korea (Seoul) :

7F Heeseung BD, 15, Seolleung-ro 131-gil, Gangnam-gu, Seoul,
Korea 06060
TEL. +82-2-546-8120 FAX. +82-2-546-8127

Korea (Busan) :

S-213 Lotte gallerium,9,Centum 1-ro, Haeundae-gu,Busan
TEL. +82-51-744-8822 FAX. +82-51-744-8833

Singapore :

111 North Bridge Road, #25-04 Peninsula Plaza Singapore 179098
TEL. +65-6720-7501 FAX. +65-6720-7505

Malaysia :

UNIT NO 25-6 & 27-6, The Boulevard, Mid Valley city Lingkaran Syed
Putra, 59200 Kuala Lumpur, Malaysia
TEL. +60-3-2282-2332 FAX. +60-3-2282-2335

Indonesia :

The Plaza Office Tower, Lt.20
Jl. M.H. Thamrin Kav.28-30 10350 Jakarta Indonesia
TEL. +62-21-2992-3111 FAX. +62-21-2992-8111

Thailand :

19 Floor, Unit 1903-1904 Sathorn Square Office Tower,
98 North Sathorn Rd, Silom, Bangrak, Bangkok 10500, Thailand
TEL. +66-2-163-2869 FAX. +66-2-163-2879

India :

The Millenia Tower B, 4th Floor, Unit 401, No. 1 and 2, Murphy Road,
Ulsoor Bangalore 560-008 India
TEL. +91-80-4650-9900 FAX. +91-80-4650-9908

Mongolia :

Sukhbaatar district 4khoroo 5-kharoolol Sain Neyen
khan Namnsuren Street 37 building No.1, Mongolia-976
TEL. +976-7012-7778 FAX. +976-7012-7708

Dubai :

Office No.105, Hassanacor Building, Al Barsha First, Dubai, UAE
TEL. +971 4 395 5011 FAX. +971 4 395 5150

Tokyo :

1-1-6 Echizenya Bld.7F, Kyobashi, Chuo-ku, Tokyo, 104-0031, Japan
TEL. +81-3-5205-6030 FAX. +81-3-5205-6035

Sapporo :

2-1-5 Regent Bld.3F, Kita2-jonishi, Chuo-ku Sapporo-shi,
Hokkaido, 060-0002, Japan
TEL. +81-11-223-5678 FAX. +81-11-223-5680

Nago :

1-3-6, Agarie, Nago-shi, Okinawa, 905-0021, Japan
TEL. +81-980-51-0616 FAX. +81-980-51-0628

Shin-Osaka

4-1-45 Shin-Osaka Yachiyo Bld.1F, Miyahara, Yodogawa-ku Osaka-shi,
Osaka, 532-0003, Japan
TEL.+81-6-6152-5407 FAX. +81-6-6152-5408

Fukuoka

1-2-5 il cassetto Bld.5F, Daimyo, Fukuoka Shi Chuo Ku, Fukuoka Ken,
810-0041, Japan
TEL.+81-92-741-4132 FAX. +81-92-741-4133

Osaka Factory :

1-40-1, Hoshidakita, Katano-shi, Osaka, 576-0017, Japan
TEL. +81-72-893-2290 FAX. +81-72-893-8007



Enagic USA
4115 Spencer Street
Torrance, CA 90503

Brand Name : LeveLuk SD501
Model Number : TYH-401
Rated Service Flow : 1.1 gallons/minute
Operating Pressure : Minimum 9 PSI 65 PSI is maximum.
Operating Temperature :
Minimum operating Temp 40 Maximum is 95 degrees F (35 degrees C)

This system has been tested according to NSF/ANSI 42 for reduction of the substances listed below. The concentration of the indicated substances in water entering the system was reduced to a concentration less than or equal to the permissible limit for water leaving the system, as specified in NSF/ANSI 42. While testing was performed under standard laboratory conditions, actual performance may vary.

This system has been tested and certified by WQA according to NSF/ANSI 42 for the reduction of chlorine, taste and odor, NSF/ANSI 372 for low lead compliance, and CSA B483.1.NSF/ANSI 18 for Food Equipment

Substance	Influence Challenge Concentration	Reduction Requirement	Average % Reduction
Chlorine, Taste and Odor	2.0 mg/L ± 10%	≥50%	98.9%

For use with cold water only.
Do not use with water that is microbiologically unsafe or unknown quality without adequate disinfection before or after the system.

Replacement Components
Replacement filter : Replacement Filter HG-N
Electrical Requirements
USA 120 V 60 Hz grounded outlet
Europe 220 - 240 V 50 - 60 Hz grounded outlet



The LeveLuk SD501 has been tested and certified by WQA according to NSF/ANSI 42 for the reduction of chlorine, NSF/ANSI 372 for low lead compliance and CSA B483.1 NSF/ANSI 18 for Food Equipment
See performance data sheet for specific performance data.

C USA

■ IMPORTANT SAFEGUARDS

• READ ALL INSTRUCTIONS BEFORE USING:

DANGER - To reduce the risk of electrocution:

1. Always unplug this product immediately after using.
2. Do not use while bathing.
3. Do not place or store product where it can fall or be pulled into a tub or sink.
4. Do not place in or drop into water or other liquid.
5. Do not reach for a product that has fallen into water. Unplug immediately.

WARNING - To reduce the risk of burns, electrocution, fire, or injury.

1. A product should never be left unattended when plugged.
2. Close supervision is necessary when this product is used by, or near children or invalids.
3. Use this product only for its intended use as described in this manual. Do not use attachments for other uses not recommended by the manufacturer.
4. Never operate this product if it has a damaged cord or plug, not working properly, has been dropped or damaged, or has been dropped into water. Return the product to a service center for examination and repair.
5. Keep the cord away from heated surfaces.
6. Never use while sleeping or drowsy.
7. Never drop or insert foreign object(s) into any openings or hose(s).
8. Do not use outdoors or operate where aerosol (spray) products are being used or where oxygen is being administered.
9. Connect this product to a properly grounded outlet only. See Grounding Instructions.

■ SAVE THESE INSTRUCTIONS

- a) This manual contains instructions for cleaning, user maintenance, and proper operations recommended by the manufacturer such as lubrication, and non-lubrication of this device. All services required by this product must be performed by an authorized service representative, which means that this product contains no user serviceable parts. This product is for household use as stated in this manual and other literature packed with the product.
- b) When a product employing an automatic reset thermal limiter (which shuts off the entire product) is used, please refer to this manual for instructions and warnings.
- c) While the product is in use, please refer to this manual for proper cord maintenance.
- d) The product is intended to be used with water, additives, conditioners, or a product that relies on the conductivity of water for normal operations (electrode type products). The use of baking soda, salt, or other substances to improve the conductivity of the water is stipulated. Please refer to this manual for specific instructions on the proper liquid or additive and the exact amount to be used in conjunction with the product.

■ GROUNDING INSTRUCTIONS

This product should be grounded. In the event of an electrical short circuit, grounding reduces the risk of electric shock by providing an escape wire for the electric current. This product is equipped with a cord having a grounding wire with a grounding plug. The plug must be plugged into an outlet that is properly installed and grounded.

DANGER - Improper use of the grounding plug can result in a risk of electric shock.

If repair or replacement of the cord or plug is necessary, do not connect the grounding wire to either flat blade terminal. The wire with insulation with an outer surface that is green with or without yellow stripes is the grounding wire. Check with a qualified electrician or serviceman if the grounding instructions are not completely understood, or if in doubt as to whether the product is properly grounded.

For all other grounded, cord connected products :

This product is factory equipped with a specific electric cord and plug to permit connection to a proper electric circuit. Make sure that the product is connected to an outlet having the same configuration as the plug. No adapter should be used with this product. Do not modify the plug provided - if it will not fit the outlet, have the proper outlet installed by a qualified electrician. If the product must be reconnected for use on a different type of electric circuit, the reconnection should be made by qualified service personnel.

Extension Cords :

If it is necessary to use an extension cord, use only a three wire extension cord that has a three-blade grounding plug, and a three-slot receptacle that will accept the plug on the product. Replace or repair damaged cord.

Mechanism of electrolysis

At cathode side, water molecule(H_2O) receives electron(e^-) and generates hydrogen molecule(H_2) and hydroxide ion(OH^-) by electrolytic reaction.

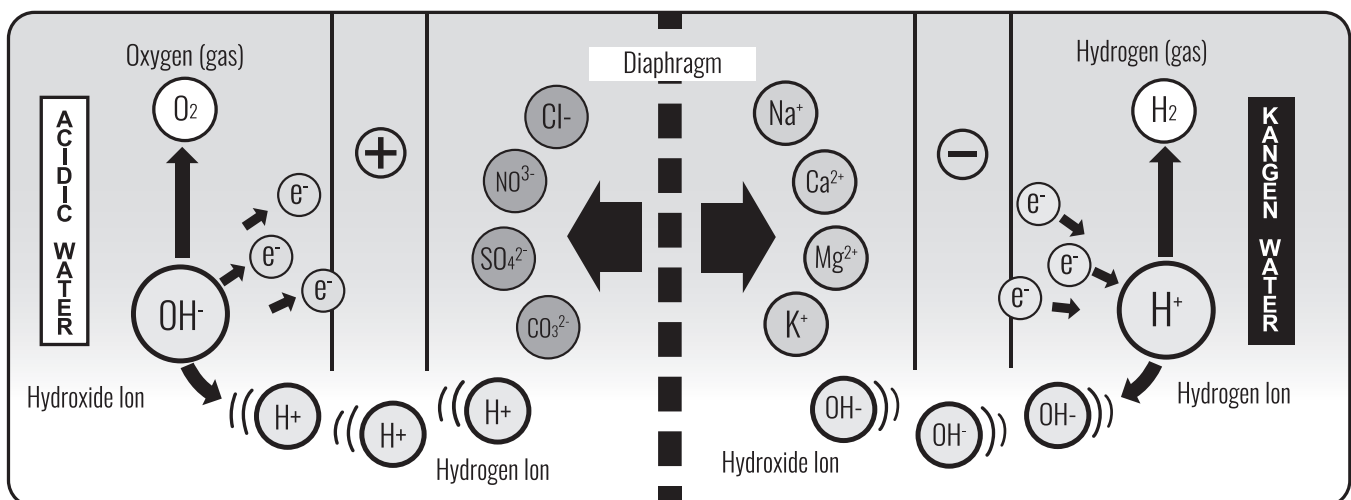

Contents



■ Introduction	4
■ Safety Precautions	5-6
■ Precautions on the use of Beauty Water and Strong Acidic Water as well as KANGEN Water	7
■ Features	8
■ Accessories	9
■ Name of each part	10-11
■ Operation panel	12
• LCD messages and voice guidance	13
1 Installation	14
• Installing the diverter	15
• Setting up the unit	16
• About the power cable	17
2 Usage	18
• How to change language preference of voice guidance / Changing the sound level	19
• Producing KANGEN Water	20-21
• Producing BEAUTY Water	22
• Producing STRONG ACIDIC Water/STRONG KANGEN Water	23-25
• Producing CLEAN Water	26
• Automatic Cleaning	27
3 Replacing the water filter (HG-N)	28-29
4 Troubleshooting	30
• Cleaning with the E-Cleaner N	31-33
5 Options	34
6 Standard Specifications	35
■ After-sales Services	Back of Manual

■ Introduction

· Indicators used in this manual

The marks in this manual indicate areas of importance, and are explained below.
Be sure to read the Warning and Caution instructions carefully.

■ Level of danger







<p> WARNING</p> <p>Indicates an imminently hazardous situation which may result in health hazards if the device is handled in a manner other than described in this manual.</p>	<p> ATTENTION</p> <p>Indicates a potentially hazardous situation which may result in minor or moderate injury if the device is handled in a manner other than described in this manual.</p>
---	---

* All the precautions described here are classified as “**WARNING**” and “**ATTENTION**”. Any potential hazardous situation which could result in death or serious physical injury are referred to under the sign “**WARNING**”. However, other potentially hazardous situations referred to under the sign of “**ATTENTION**” can also present serious danger, depending on the case and situation. All the precautions, therefore, should be observed strictly.

* The maker of this product is not responsible for any damage to the product or accidents caused by improper use or by disregarding the precautions mentioned in this manual.

* After reading this manual, please keep it in a safe place for future reference.



■ Description of signal marks

Mark	Title	Significance
	General	Used to indicate general precautions, warnings and dangers.
	General	Used to notify general prohibition precautions, warning and danger.
	General	Used to describe behavior of general users.
	Open flames	Used to warn against any behavior that could result, under certain conditions, in the unit catching fire as a result of proximity to flame.
	Prohibition of use at water splashing place, such as, bath or shower room.	Used to prohibit use of the product through using near baths or in showers, or any place where the unit may come in contact with water, the unit is not waterproof.
	Disassembly	Used to warn against self-repair or taking apart the unit by oneself, which could cause electric shock or other injuries.
	Unplugging	Used to indicate to the user when it is necessary to unplug the product, especially when it is showing signs of being damaged, or when a thunderstorm is expected.

■ Safety Precautions

■ To avoid injury or accident, please adhere to the following rules.

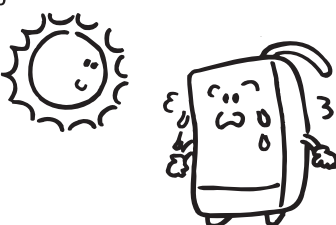
⚠ WARNING	
 Prohibited	<ul style="list-style-type: none"> ● Please take the following precautions prior to drinking KANGEN Water. <ul style="list-style-type: none"> • Do not take medication with KANGEN Water. • If you experience any discomfort in your health condition, please consult your physician or pharmacist. • If you are under a physician care, or are experiencing physician care, or are experiencing physical abnormality, please consult your physician or pharmacist before using. ● Use only municipally treated water approved for drinking such as tap water. <ul style="list-style-type: none"> • The unit's chlorine removal ratio and pH value may vary according to the water quality of different localities.
	<ul style="list-style-type: none"> ● Please supervise children and senior citizens while they use the machine. ● This appliance can be used by children age from 8 years and above and persons with reduced physical, sensory or mental capabilities or lack of experience and knowledge if they have been given supervision or instruction concerning use of the appliance in a safe way and understand the hazards involved. Children shall not play with the appliance. Cleaning and user maintenance shall not be made by child without supervision.
	<ul style="list-style-type: none"> ● Failure to comply with all of the following warnings may cause electric shock, fire or accidents and can result in severe personal injury and or damage to property. <ul style="list-style-type: none"> • Do not splash water or oil on the body. • Never run the unit with a damaged power supply cord. • Do not tamper with or attempt to repair the unit.
	<ul style="list-style-type: none"> ● Stop use immediately and unplug the power plug when there are aberrations or malfunctions. Failure to do this may cause smoke generation, fire ignition or electric shock. Unplug the power plug, have the product inspected and repaired.

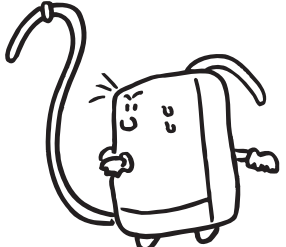
⚠ ATTENTION	
<ul style="list-style-type: none"> • Avoid direct sunlight. May cause the unit to bend or warp. 	<ul style="list-style-type: none"> • Do not use thinner, benzene, cleansers or chlorine-based detergents for cleaning. May damage the unit. 
<ul style="list-style-type: none"> • Do not splash water or oil on the body. May cause fire or electric shock. 	<ul style="list-style-type: none"> • Do not use the unit when the secondary water hose is in an elevated position. Water cannot flow out of the unit and therefore it may cause damage. 

⚠ ATTENTION

- **Do not place the unit near hot objects or in the presence of corrosive gas.**

May damage or cause the unit to bend or warp.

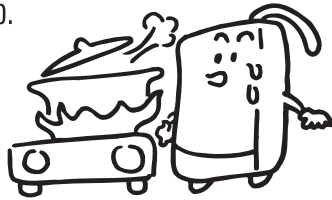

- **Do not use processed water in aquariums or give to pets.**

The change in the pH may kill fish or small living creatures.

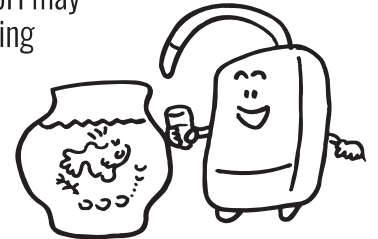

- **Never place anything on the unit.**

It may cause damage or fall.

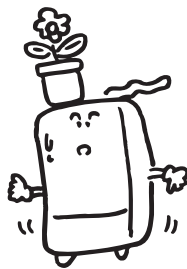

- **Do not use salt water or excessively hard water.**

The unit may be damaged, or its service life will be shortened.

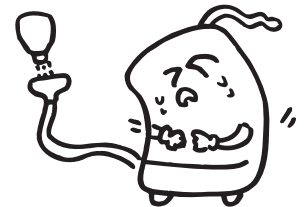

- **If you want to move the unit, first remove the electrolysis enhancer tank.**

Leaking from the electrolysis enhancer may cause trouble.

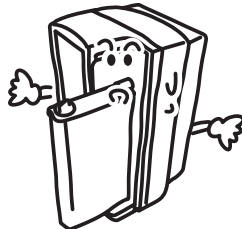

- **Never run hot (40°C or higher) into the unit.**

It may damage or cause malfunctions.

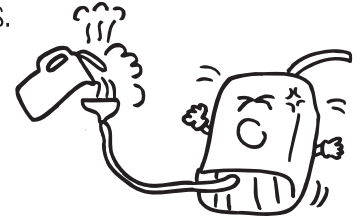

- **Never run the unit with a damaged power supply cord.**

It can cause a fire, electric shock or malfunction.

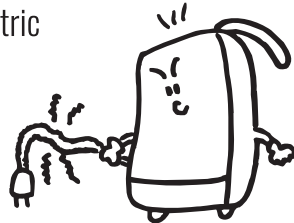

- **When using the unit in a area with cold temperatures please avoid running freezing water into the unit (When you are not using the unit for a long period of time, remove the water filter and keep it separately from the unit. At the time, do not touch the reset switch).**

Failure to do so can result in damage or malfunction.



- **Do not tamper with or attempt to repair the unit.**

It can cause a fire, electric shock or accidents.

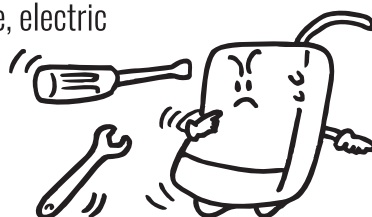



Please observe

■ Precautions on the use of Beauty Water and Strong Acidic Water as well as KANGEN Water

WARNING - Please observe carefully-

 <p>Please observe</p>	<ul style="list-style-type: none"> • Please consult with your physician before using Beauty Water or Strong Acidic Water if you have any of the following. <ul style="list-style-type: none"> ■ Sensitive skin ■ Allergies • If you experience any skin irritation after using any type of Beauty Water, discontinue use and consult with your physician. • Please take the following precautions prior to drinking KANGEN Water: <ul style="list-style-type: none"> ■ Do not take medication with KANGEN Water. ■ Do not drink KANGEN Water if you have kidney problems such as kidney failure or trouble processing potassium. ■ If you experience any discomfort please discontinue use and consult with your physician. ■ If you are under the care of a physician please consult with them prior to drinking KANGEN Water. ■ Do not use KANGEN Water with baby formula or baby foods.
--	--

ATTENTION

 <p>Prohibited</p>	<ul style="list-style-type: none"> • Do not drink any of the following types of water; they may negatively affect your health. <ul style="list-style-type: none"> ■ Strong Acidic Water ■ Beauty Water ■ Cleaning cycle water ■ Water containing pH test liquid ■ Strong KANGEN Water during the production of Strong Acidic Water ■ Water being discharged from the secondary water hose • When drinking KANGEN Water, adjust the pH value to 9.5 or lower. It is not recommended to drink water with a pH over 10.0. Check the pH regularly. • Do not use KANGEN or Beauty Water in fish bowls or aquariums; changes in pH may kill the fish. • Do to the fact that copper containers are acid-sensitive and aluminum containers are alkaline-sensitive they should not be used.
 <p>Please observe</p>	<ul style="list-style-type: none"> • Please drink the KANGEN Water as soon as possible after it is made. • Use containers made of glass, plastic, ceramic, or other non-corrosive materials when storing Strong Acidic Water. Metal containers will corrode when in contact with Strong Acidic Water and should never be used. • Store Strong Acidic Water in a tightly sealed container that is impermeable to light. Use stored contents within one week. • Metal knives or spoons cleaned with Strong Acidic Water or Beauty Water must be dried. Rust can develop if the utensils are left wet. • Store KANGEN Water in a sealed container and keep refrigerated. Use the contents within 3 days. • Run water through the machine for 15 minutes when you first use a new filter. • Let the water flow for more than 10 seconds before your first use of the day. • If the unit has been unused for 2-3 days, let the water flow for more than 30 seconds. • Please follow local laws and regulations when disposing of used filters.

■ Features

This product is capable of producing 5 types of water.

- STRONG ACIDIC Water ■ STRONG KANGEN Water ■ KANGEN Water ■ BEAUTY Water
 ■ CLEAN Water

All at a touch of the button to suit your specific needs.

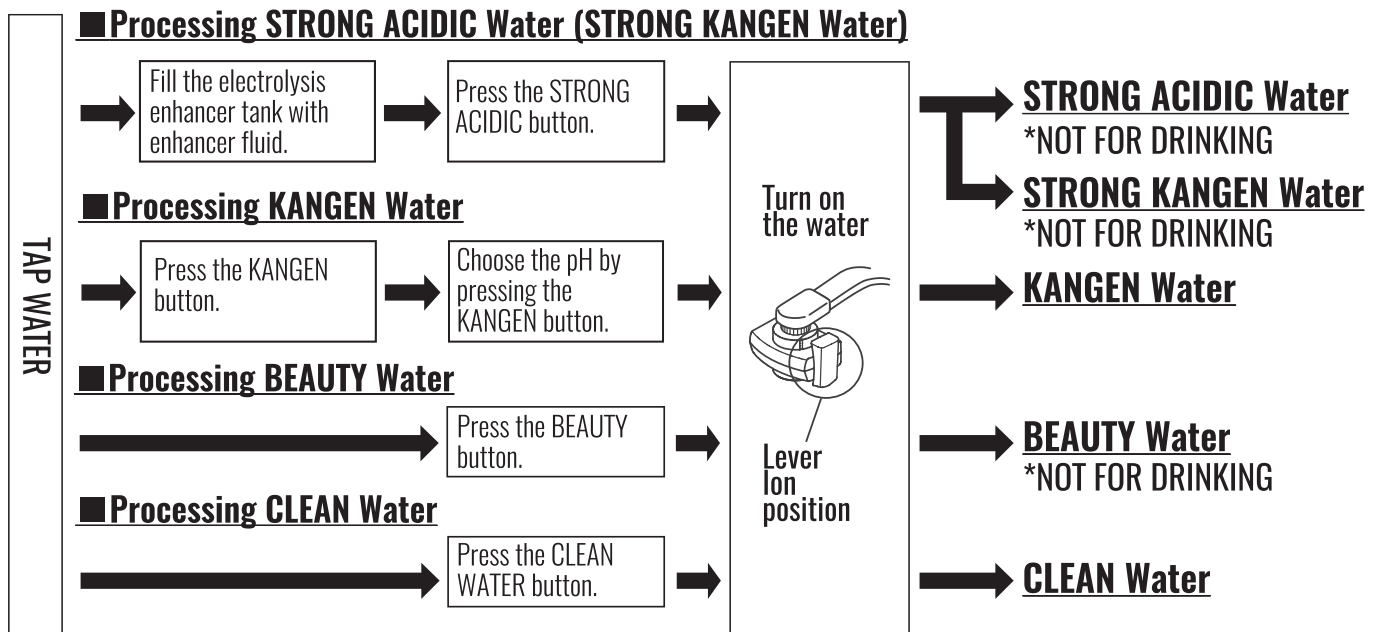

■ 5 types of water, subdivided into 7 according to pH, are available to suit your specific need.

Processed water	pH level	Use	⚠ ATTENTION
KANGEN Water	pH9.5	Making herb tea, mild herb tea Most suitable for making oolong tea.	Do not take medicine with KANGEN Water. When taking medicine, select the CLEAN Water mode.
	pH9.0	Making green tea, coffee and cooking rice Your green tea or coffee will taste mellow, and your rice will cook soft and full.	
	pH8.5	Your Starting Point This pH level is recommended for people to get used to KANGEN Water.	
CLEAN Water	pH is same as tap water	To be taken with medicine or preparing baby formula This clean water can be used as water to be taken with medicine as well as water you can drink every day.	_____
BEAUTY Water	pH6.0	For your skin care To be used as astringent water, bath water.	NOT FOR DRINKING
STRONG ACIDIC Water	pH2.5	To be used as disinfectant or cleaning This water washes clean your kitchen utensils such as cooking knives, cooking boards, and washes cups and saucers stain-free. It also destroys pathogenic bacteria on fruit.	
STRONG KANGEN Water	pH11.0	Has the power to dissolve tough stains Use the added power of Strong KANGEN Water to remove tough kitchen grease stains or cleaning floors. Use to wash fish, meat, and vegetables.	

(For producing various types of water, see "Usage" on P.18 and on.)

⚠ WARNING



Please observe

When producing Strong Acidic Water, please make sure the room is well ventilated and avoid prolonged breathing of the vapors.

Accessories

• Accessories

About installation

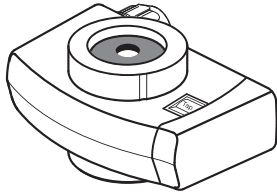

① Diverter

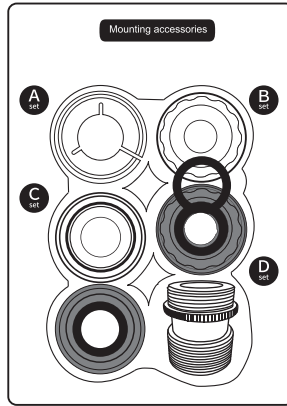

② Adapter set

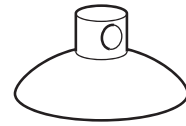

③ Suction cup
(1 pcs.)

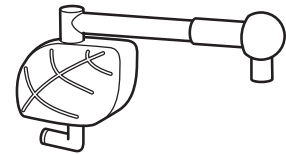

④ Secondary water stand
(with suction pad)

About the usage



⑤ Electrolysis enhancer



⑥ Funnel

pH test liquid



Test tube

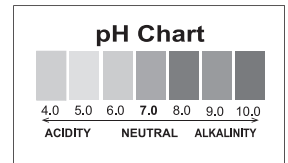

pH color chart

⑦ pH test liquid set

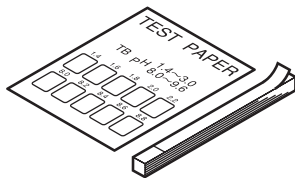

⑧ pH test paper

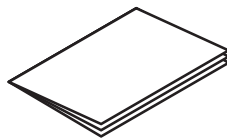

⑨ Operation manual



⑩ Water filter change label

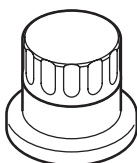

⑪ Cleaning powder Unit (CPU-N)



⑫ Cleaning powder

■ Name of each part

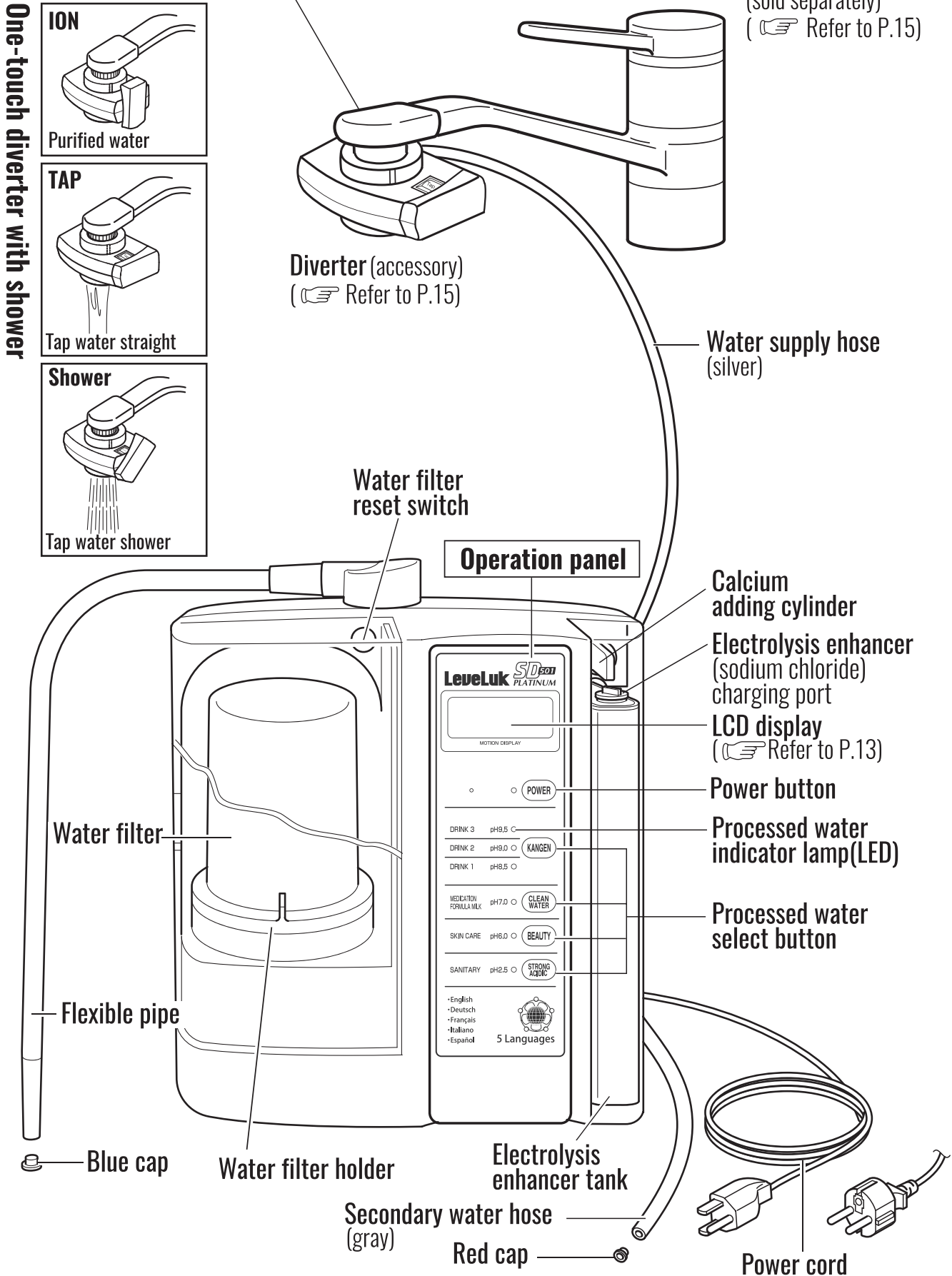

<Top view>

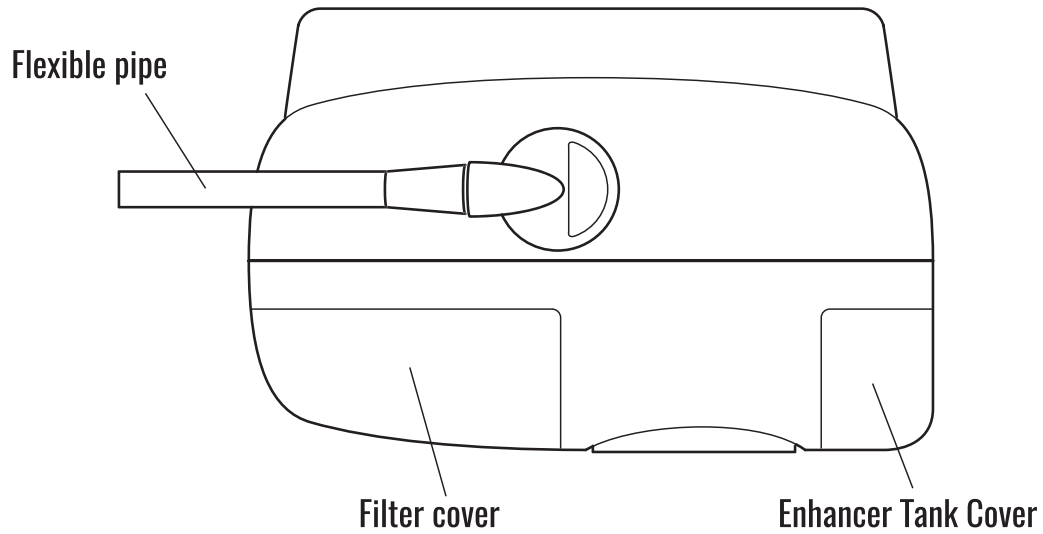

<Bottom view>

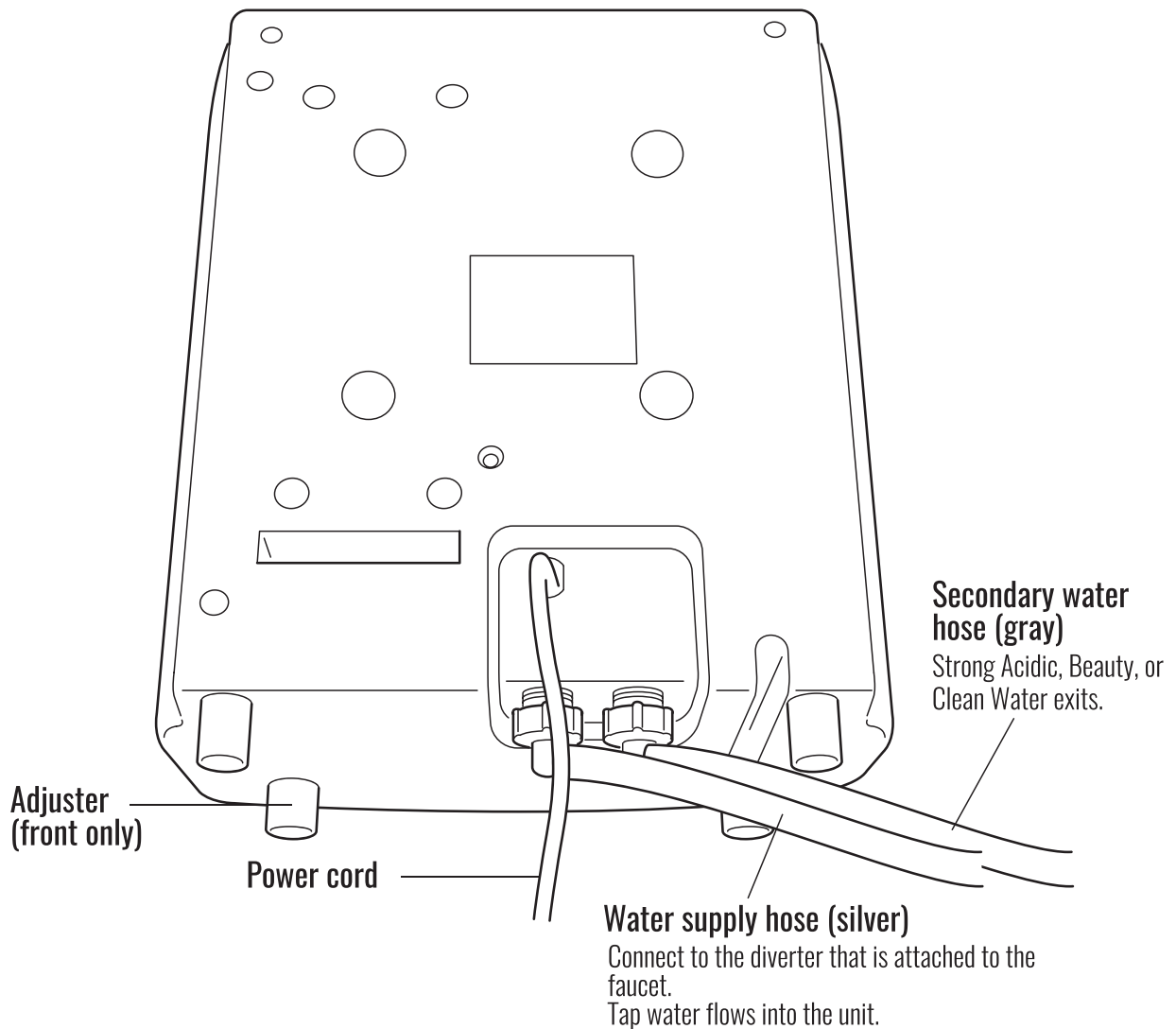

■ Operation panel

Note: The unit has been shipped with the panel protective sheet over the control panel. Please peel off this sheet before using.

Panel protective sheet

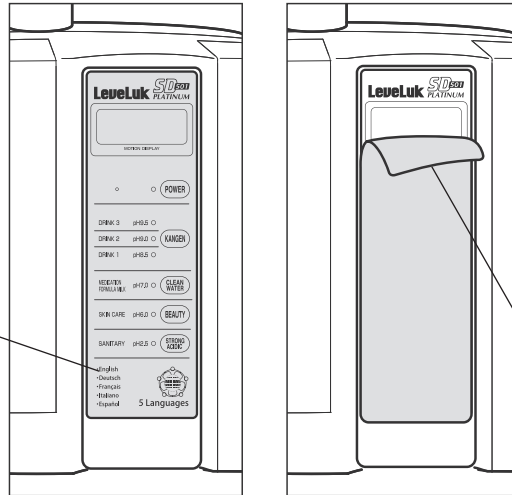

Please peel off this sheet before using.

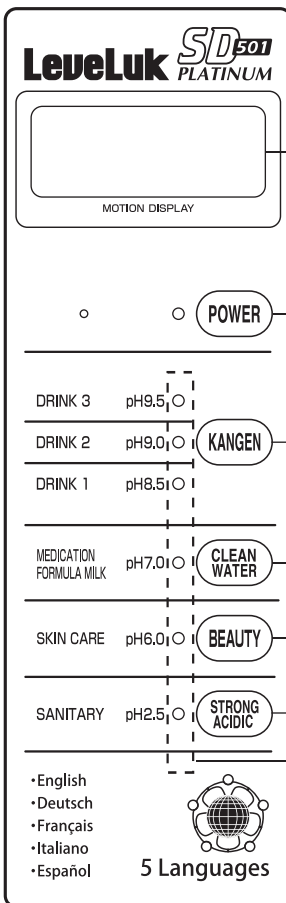

LCD display (☞ Refer to P.13)
Displays current operating status.

Power button / lamp
Used to turn power on and off.
When on, the power lamp lights up red.

Processed water select button

Processed water indicator lamp

LCD messages and voice guidance

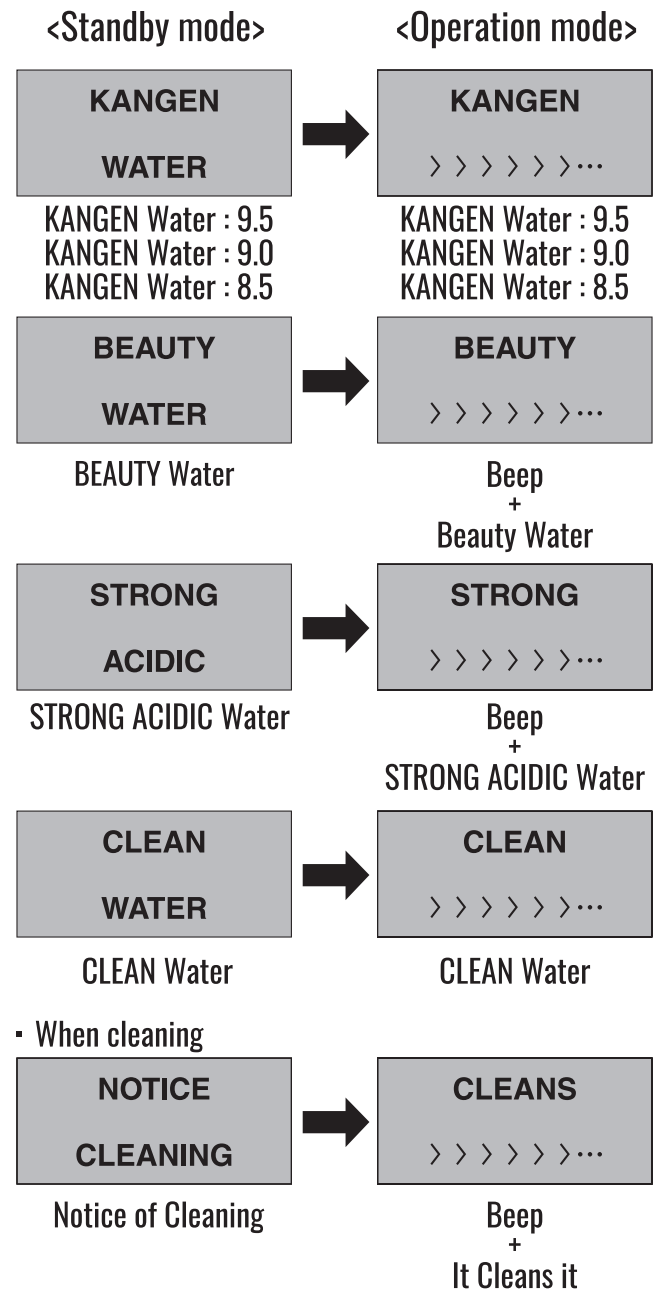

- When switching sound level.

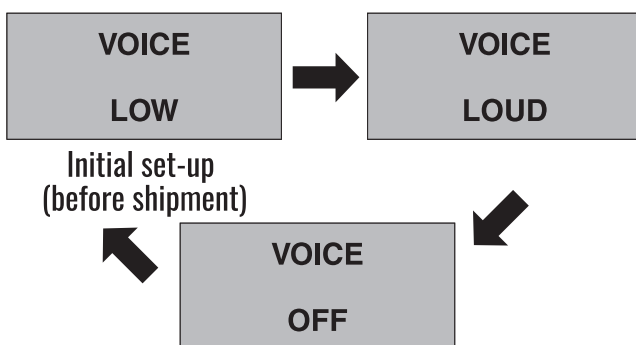

<Other mode>

- When water flow is too fast (Beauty Water and Strong Acidic Water modes only).

DECREASE
FLOW

Beep
+
Decrease Flow

- When running out of electrolysis enhancer or no electrolysis enhancer, while Strong Acidic Water production is in process.

RE-FILL
SOLUTION

Beep
+
Re-Fill Specified Solution

- When pressing the water filter reset switch.

FILTER
RESET

Beep
+
Filter Reset

- Displays for 3 seconds after plugging into power cable.

○○○○○○H
○○○○○○○H

Switch-on operation is not possible while this is displayed. Press the Power Button when this display disappears.

- When water supply (pressure) is insufficient.

INCREASE
FLOW

Beep
+
Increase Flow

- When the unit is overheated.

HEAT
PROTECT

Beep
+
Heat Protection

Close the faucet and switch it off. Then wait for more than 30 minutes or longer depending on the environment.

- When hot water enters.

HOT RUN
PROTECT

Beep
+
Hot Run Protection

- When water filter needs to be replace.

REPLACE
FILTER

Beep

1 Installation





■ Selecting a location

⚠ ATTENTION

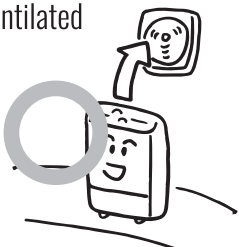

- Do not place anything on the machine. (Trouble or falling may result.)
- Do not close the secondary water hose opening. (Can cause water leak or electrolytic error.)
- Check the secondary water hose to see if it is twisted or bent. (Can cause water leak or electrolytic error.)
- Keep the secondary water hose level lower than the level of the machine. (Otherwise, the water in the machine will not drain properly.)
- Do not move or transport the machine with electrolysis enhancer fluid in the electrolysis enhancer tank. May cause damage due to leaking fluid.
- Install this system in compliance with state and local regulations.

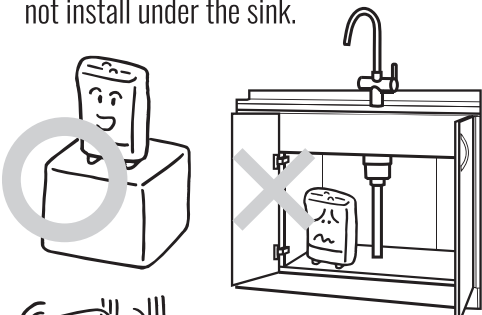
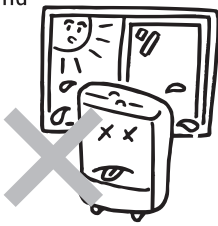
• Install in the following types of location

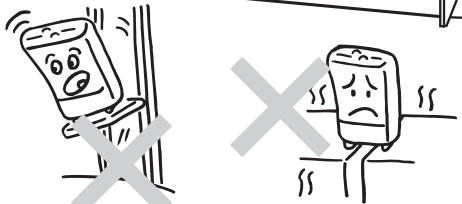
<ul style="list-style-type: none"> • In a well ventilated area. 	<ul style="list-style-type: none"> • An area away from flammable objects. • In an area with room temperature between 5 to 40°C. 	<ul style="list-style-type: none"> • On a flat stable counter top area capable of supporting the weight of the machine. Do not install under the sink. 
<ul style="list-style-type: none"> • An area not exposed to direct sunlight, wind or rain. 	<ul style="list-style-type: none"> • An area free from splashing water, steam, chemicals and dust. 	

■ Installing the unit

Install on a kitchen counter.

Note: Install on a flat place. Do not connect the product to a faucet used solely for hot water.

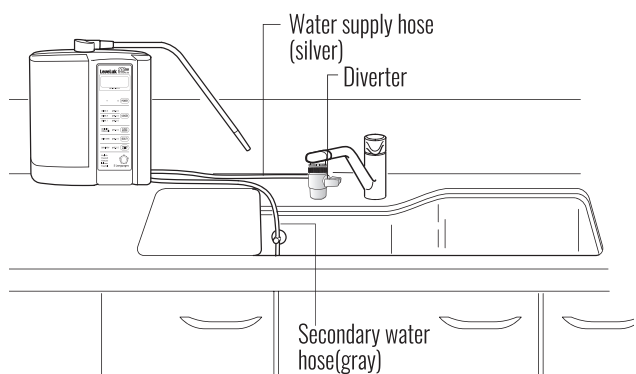

IMPORTANT NOTE :

The original parts used for Enagic products are designed to provide functionality and safety. For this reason, ENAGIC does not approve the use of aftermarket or imitation products. In particular, installing any product other than the SD-U under the sink is strictly prohibited.

-Parts Warranty-
Enagic warranty does not cover damages or failure of its products when used with third party products. ENAGIC is not responsible for failure, accident or damage resulting from the use or modification of parts other than genuine ENAGIC parts.

Installing the diverter

■ The diverter may fall to fit on some types of faucets. Check the type of faucet beforehand. Then fit the diverter on the faucet in the specified manner.



Do not use a tool to tighten the fixing nut because this may cause the fixing nut to break.

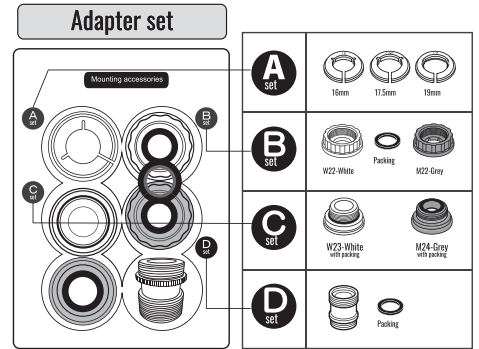
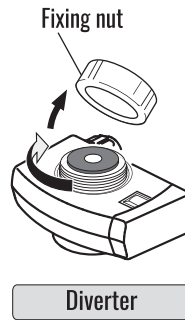

Faucet with expanded end	Outer screw type	Inner screw type	Inner screw type
<p>Install a adapter that matches the faucet diameter.</p> <p>< Adapter used ></p> <p>A SET</p> <p>Fixing nut</p> <p>Tighten the fixing nut.</p>	<p>Remove the aerator</p> <p>Store the removed aerator.</p> <p>< Adapter used ></p> <p>B SET</p> <p>Fixing nut Packing Adapter B (Grey or White)</p> <p>Use a coin to tighten the Adapter B.</p> <p>Tighten the fixing nut.</p>	<p>Remove the aerator</p> <p>Store the removed aerator.</p> <p>< Adapter used ></p> <p>C SET</p> <p>Fixing nut Packing Adapter C (Grey or White)</p> <p>Use a coin to tighten the Adapter C.</p> <p>Tighten the fixing nut.</p>	<p>Remove the aerator</p> <p>Store the removed aerator.</p> <p>< Adapter used ></p> <p>B SET + D SET</p> <p>Packing Adapter D Fixing nut Packing Adapter B (Grey)</p> <p>Tighten the fixing nut.</p>

! If the thread diameter or thread does not fit, the threads may get damaged. Make sure the thread diameter and pitch are as specified.

The faucets shown at right cannot accept the diverter.

Faucets with a shower nozzle	With a sensor	Screw diameter does not match	Faucet whose nozzle part is short	Square faucets
		<ul style="list-style-type: none"> When the accompanying Adapter not fit. <p>0.88 inch / 22 mm is OK</p>	<p>0.4 inch / 10 mm or less</p> <p>0.96 inch / 24 mm or more</p>	

In this case, add a dedicated faucet or install the specific diverter. For details, contact your dealer.

Setting up the unit

■ Install according to the order (1 to 4).

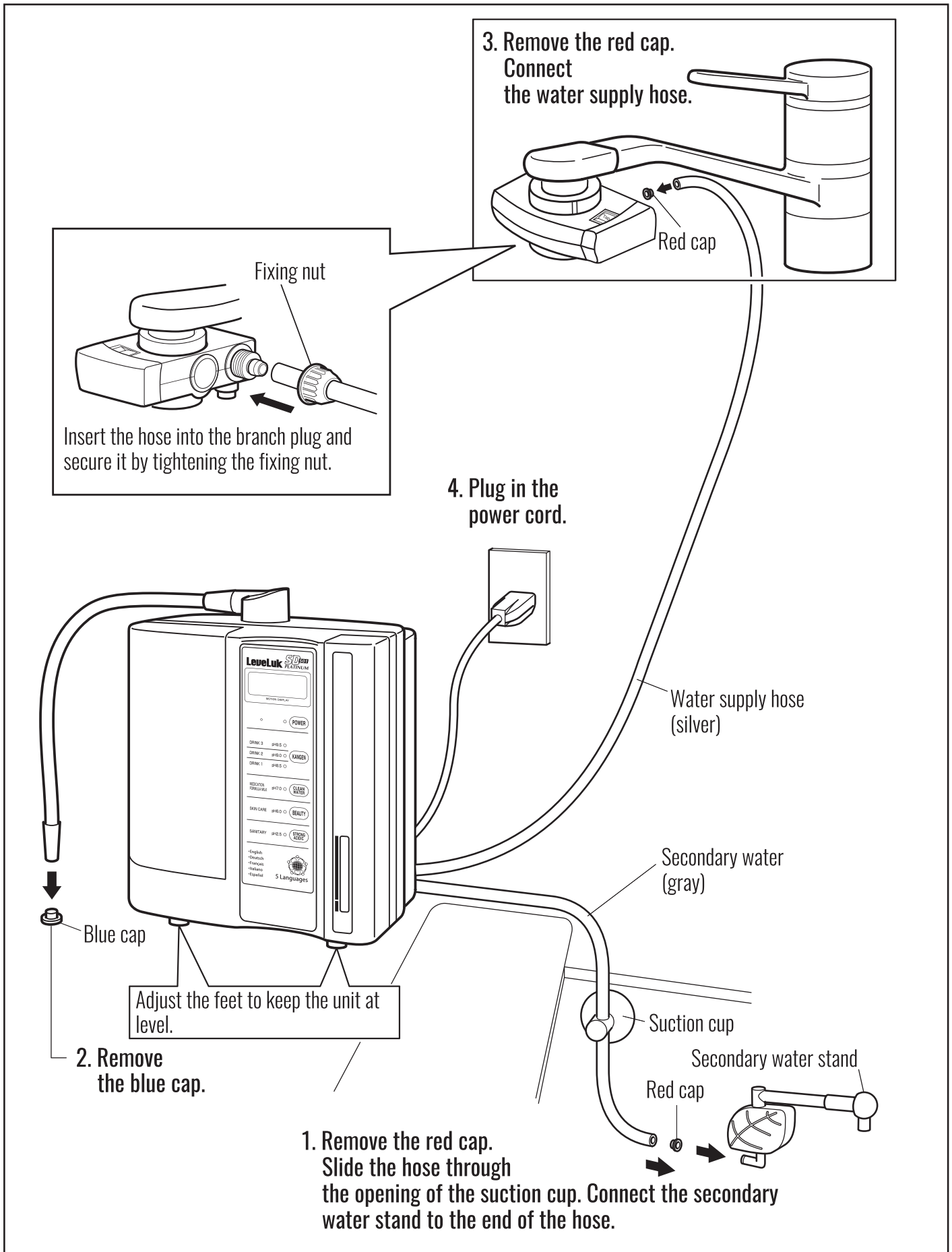

About the power cable

■ Please use the outlet of AC 120 V 60 Hz (USA) / AC 220–240 V 50–60 Hz (Europe and Some parts of Asia) for household use.

* Using improper voltage will void the warranty.

WARNING



Prohibited

- Never bend, pull, twist, or bundle the power cord. Do not lay heavy objects on top of the cord or clamp the cord.
This may damage the cord, and cause electric shock that may lead to hazardous fire.
- Do not use a damaged power cord or loosely fitted one.
It may cause electric shock, short circuit or fire.
- Stapling the power cord is strictly prohibited.
This will cause irreparable damage to the cord and possibly fire.
- Do not plug too many plugs into one outlet.
- Connect or disconnect the power plug by holding the plug instead of the cord. Pulling the cord can cause breakage, fire, and/or electric shock.
- Use only the proper power supply/voltage.
Using improper power source/voltage can cause fire or electric shock.

ATTENTION



Please observe

- Insert the power plug firmly. If the plug and connector is not inserted properly, electric shock or a fire caused by heat generation may result.
- Be sure to check that all buttons work properly.
- Please bundle the cord during storage to avoid damage.
- If the supply cord is damaged, it must be replaced by the manufacturer, its service agent or similarly qualified persons in order to avoid hazard.



- A wet plug can cause electric shock. If the power plug is severely wet.
 - (1) Disconnect the plug from the outlet
 - (2) Wipe the water off the plugs
 - (3) Consult your local dealer for repairs
- Never handle power plugs with wet hands. If power plug is wet, first disconnect it completely from the outlet and wipe it dry. Failure to follow these procedures may result in electric shock.
- When cleaning the outlet, first disconnect the power plug. Dust on outlets can cause fire.
- Always unplug this product after use.



2 Usage

■ This processor operates in four basic modes to process 5 types of water as follows:
KANGEN Water, BEAUTY Water, STRONG ACIDIC Water, STRONG KANGEN Water and CLEAN Water.

■ Basic modes of operation

Water type	Control panel and faucet operation	Processed water type and water collection point
<p>① KANGEN Water</p> <p>⚠ WARNING Not to be taken with medicine.</p>	<p>Press the "KANGEN" button and turn on the faucet.</p> <p>To change the pH value, press the "KANGEN" button first and select the value you wish to get. (3 settings)</p> <p>pH9.5 ③ Press the button. pH9.0 ② Press the button. pH8.5 ① Press the button.</p> <p>(REPEAT)</p>	<p>KANGEN Water (pH 8.5/pH 9.0/pH 9.5) Discharged from <i>the flexible pipe</i></p> <p>BEAUTY Water Discharged from <i>the secondary water hose</i></p> <p>⚠ WARNING NOT FOR DRINKING</p>
<p>② CLEAN Water</p>	<p>Press the "CLEAN WATER" button and open the tap water faucet.</p>	<p>When taking medicine, select the CLEAN Water mode.</p> <p>CLEAN Water (pH 7.0) Discharged from <i>the flexible pipe</i> Water discharged from the secondary water hose is also CLEAN Water, but collect CLEAN Water from the flexible pipe.</p>
<p>③ BEAUTY Water</p> <p>⚠ WARNING NOT FOR DRINKING</p>	<p>Press the "BEAUTY" button and open the tap water faucet.</p>	<p>BEAUTY Water (pH 6.0) Discharged from <i>the flexible pipe</i></p> <p>⚠ WARNING NOT FOR DRINKING</p> <p>KANGEN Water Discharged from <i>the secondary water hose</i></p> <p>⚠ WARNING NOT FOR DRINKING</p>
<p>④ STRONG ACIDIC Water</p> <p>To be discharged simultaneously with strong KANGEN Water.</p> <p>⑤ STRONG KANGEN Water</p> <p>⚠ WARNING NOT FOR DRINKING</p>	<p>Check the level of the fluid in the electrolysis enhancer tank and press the "STRONG ACIDIC" button. Open the tap water faucet.</p>	<p>STRONG ACIDIC Water (pH 2.5) Discharged from <i>the secondary water hose</i></p> <p>⚠ WARNING NOT FOR DRINKING</p> <p>STRONG KANGEN Water (pH 11.0) Discharged from <i>the flexible pipe</i></p> <p>⚠ WARNING NOT FOR DRINKING</p>

⚠ ATTENTION

 Prohibited	<ul style="list-style-type: none"> • Different operating procedures are required to produce different types of water. • Procedures must be strictly followed.(Refer to P. 20) • Improper operation or setting may result in faulty operation.
 Please observe	<ul style="list-style-type: none"> • Run water through the machine for 15 minutes when you first use a new filter. • Let the water flow for more than 10 seconds before your first use of the day. • If the unit has been unused for 2–3 days, let the water flow for more than 30 seconds.

How to change language preference of voice guidance / Changing the sound level

■ Press the CLEAN WATER button on the operation panel to change the language setting of the voice guidance. Default language is set to English (factory default)

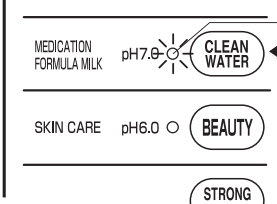
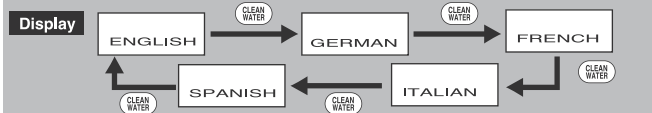
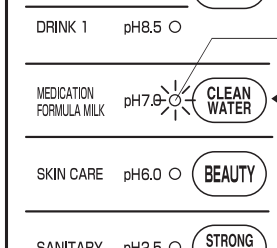
<p>1</p>	<p>Press the CLEAN WATER button with the power off until the Clean Water indicator lamp blinks (for three seconds).</p>	 <p>Lamp Press the button for 3 or more seconds</p>
<p>2</p>	<p>While the CLEAN WATER indicator lamp is blinking, you can change the voice guidance language. To change the language press the CLEAN WATER button (see diagram below).</p> 	 <p>While the lamp blinks. Press</p>
<p>3</p>	<p>If 15 seconds have elapsed without any operation or any button other than the CLEAN WATER button (POWER, KANGEN, BEAUTY or STRONG ACIDIC) is pressed, the power will turn off and the language setting will take affect once the power is turned on.</p>	

■ The sound level of voice guidance can be changed by selecting the button on the operation panel.

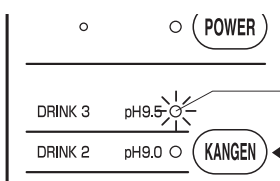
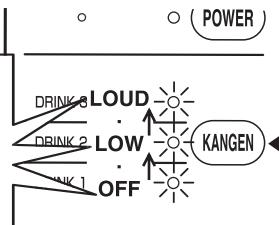
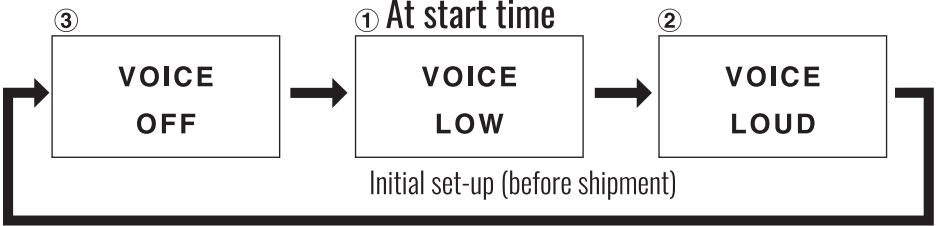
<p>1</p>	<p>With the power off, press the KANGEN button for about 3 seconds to select the sound level adjust mode.</p> <p>> The KANGEN Water lamp blinks.</p>	 <p>Lamp blinks Press for 3 sec.</p>
<p>2</p>	<p>While the lamp is blinking, press the KANGEN button to select sound level.</p> <p>> Message on LCD (In sound level adjust mode)</p>	<p>Press while the lamp is blinking. Each press of button changes the level to LOUD-OFF-LOW.</p>  <p>Press</p> 
<p>3</p>	<p>Once the sound level setting is complete, the power turns off after 15 seconds, or the power turns off immediately by pressing any button (such as POWER, CLEAN WATER, BEAUTY or STRONG ACIDIC) other than the KANGEN button.</p> <p>•Return the unit to KANGEN Water mode by pressing the power button again.</p>	

Producing KANGEN Water

⚠ ATTENTION



Please observe

- Do not take medicine with KANGEN Water.
- Do not use processed water while the LED is blinking.
- When starting to use the unit, flush out the water which has collected inside.
- Run water through the machine for 15 minutes when you first use a new filter.
- When starting use every day, run about 10 seconds water through the unit.
- When the unit has not been used for 2 or more days, run about 30 seconds water through the unit.
- The first time the machine is used or after a filter change the water may appear cloudy. (The cloudiness is caused by settling of the activated charcoal filter. Continue to run the water until the cloudiness goes away. Do not drink the cloudy water.)

1

Press the **POWER** button to turn on the power.

> The POWER lamp come on.

The button sound + voice guidance

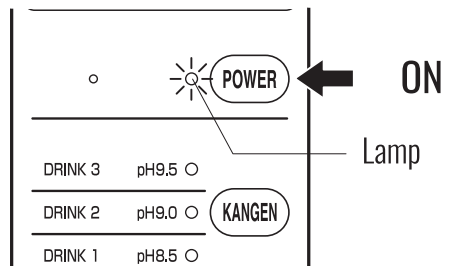

2

Press the **KANGEN** button to select the KANGEN Water mode and the pH value (pH 9.5, pH 9.0, pH 8.5)

> Each time the button is pushed it changes over the mode serially in 3 phases and the lamp comes on.

The button sound + voice guidance

Note : The pH value varies according to local water characteristics and water pressure.

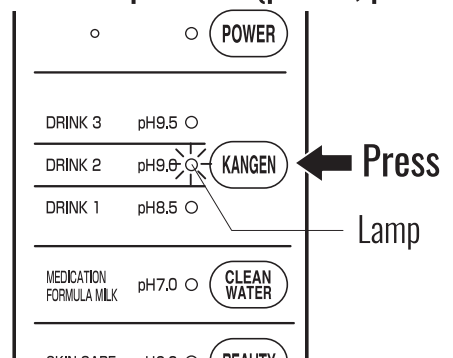

3

① Set the lever of the diverter to ION then run the water to begin processing water.

⚠ ATTENTION

If the water flow (pressure) is too low, the voice guidance and alarm sound starts and the message appears on the display.
(See P.13) " Increase water flow"

② Processed water will be discharged.

- > KANGEN Water is discharged from the flexible pipe.
- > BEAUTY Water is discharged from the secondary water hose.

Voice guidance

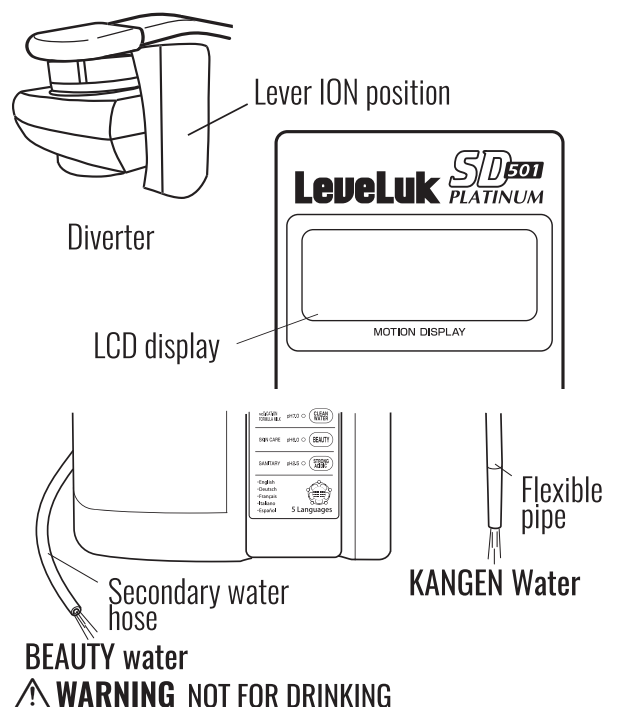

How to stop operation

4

Turn off the faucet to stop production of water.

If you wish to produce water continuously, follow step 3 of the operation procedure.

For adding glycerophosphoric acid calcium (optional)

- Take off the tank cover and turn the cap of calcium adding cylinder located at the top right corner of the unit clockwise to remove it. Add about 2 grams of glycerophosphoric acid calcium into the adding cylinder (to about 80% volume of the total cylinder capacity).
- Place the cylinder back in the cylinder cap, then return to its original location making sure the twist knob is vertical and in the closed position.

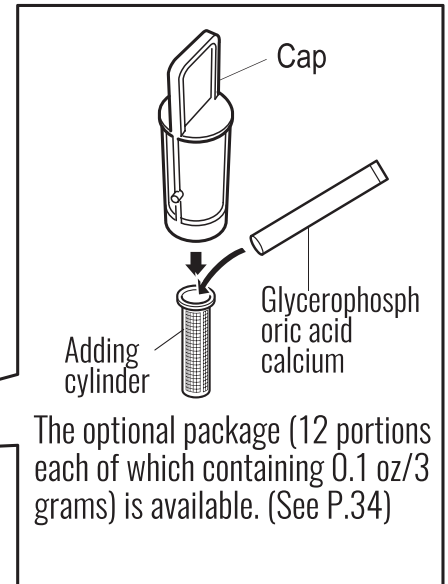
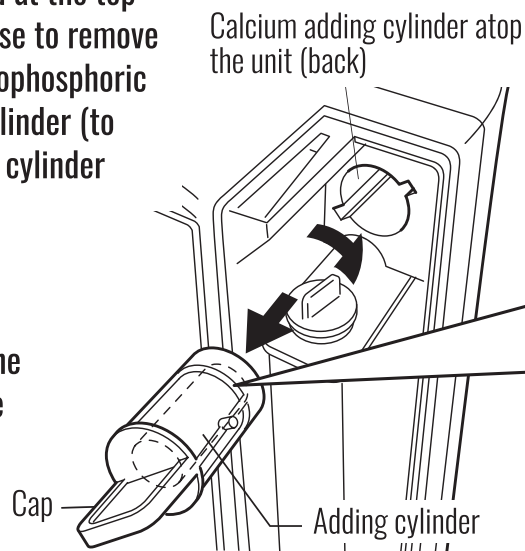

⚠ ATTENTION

- Glycerophosphoric acid calcium increase the calcium concentration in the KANGEN Water.
- This process also increases the pH concentration: Set the proper pH level of the unit by pressing the “KANGEN” button when adding glycerophosphoric acid calcium.
- If glycerophosphoric acid calcium is used, regular cleaning of the calcium cylinder is required so that no calcium clogs the cylinder screen.

How to measure pH value of KANGEN Water

- Measure the pH value of the KANGEN Water by using the pH test liquid at least once a month.

Optimum pH

Potable range ... pH8.5-9.5

⚠ ATTENTION

- The pH value varies according to local water characteristics and water pressure.

pH test liquid set

1. Put KANGEN Water in the included test tube about 0.8 inch deep.



- The pH is unsteady in water initially processed. Therefore, flow the water for approximately 10 seconds before sampling.

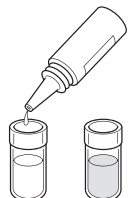

2. Add about 1-2 drops of test liquid in the tube and shake the content well.



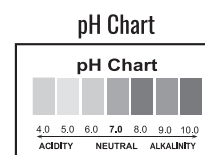

3. Compare the color of the water in the test tube with that of the color chartpaper and check the pH concentration.

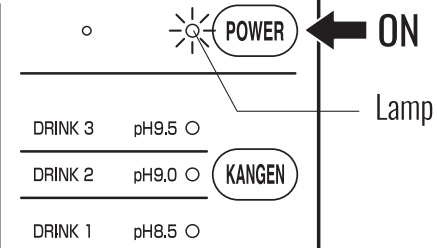

- Do not drink the water in the test tube after testing.
- Keep the testing liquid in a cold and dark place.
- Store the testing liquid out of children's reach.

Producing BEAUTY Water

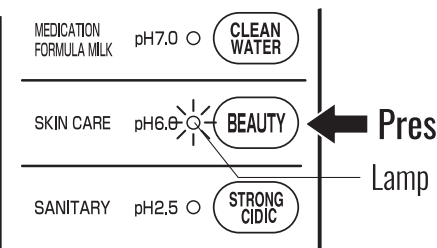
! WARNING BEAUTY Water is not for drinking.

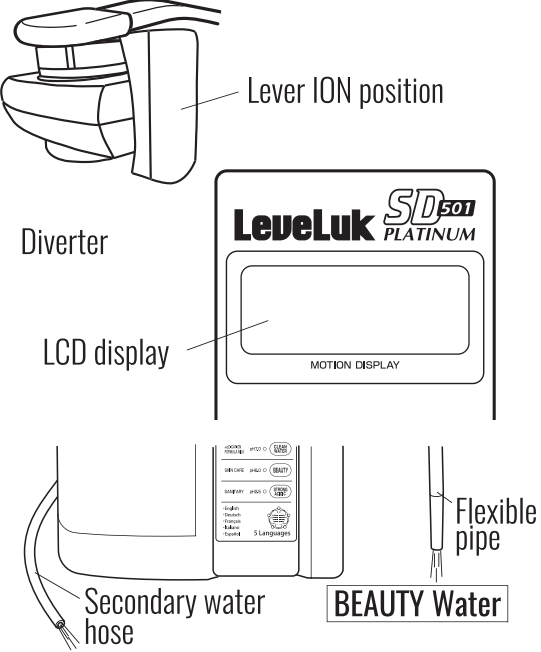
<p>1</p>	<p>Press the POWER button to turn on the power. > The POWER lamp come on.  The button sound + voice guidance</p>	
<p>2</p>	<p>Press the BEAUTY button > The BEAUTY lamp come on.  The button sound + voice guidance</p>	
<p>3</p>	<p>① Set the lever of the diverter to ION then run the water to begin processing water.</p> <div data-bbox="231 1086 858 1288" style="border: 1px solid black; padding: 5px;"> <p>! ATTENTION If the water flow (pressure) is too low, the voice guidance and alarm sound starts and the message appears on the display. (See P.13)</p> </div> <p>② Processed water will be discharged. > BEAUTY Water is discharged from the flexible pipe and a beeping sound will be made when water is production.  Voice guidance + Alarm sound</p>	 <p>! WARNING NOT FOR DRINKING</p>
<p>4</p>	<div data-bbox="199 1680 518 1747" style="border: 1px solid black; padding: 5px;"> <p>How to stop operation</p> </div> <p>Turn off the faucet to stop production of water. (If you wish to produce water continuously, follow step 3 of the operation procedure.)</p>	

Producing STRONG ACIDIC Water / STRONG KANGEN Water

⚠️ WARNING

- When producing Strong Acidic Water, please make sure the room is well ventilated and avoid prolonged breathing of the vapors.

⚠️ ATTENTION

- To produce Strong Acidic Water, be sure to put the electrolysis enhancer in the tank unit before operating.
- Use genuine electrolysis enhancer recommended by manufacturer.
- While cleaning, let the water flow freely.

■ How to add electrolysis enhancer (attached)

- ① Take out the tank cover and remove the cap of the electrolysis enhancer port.

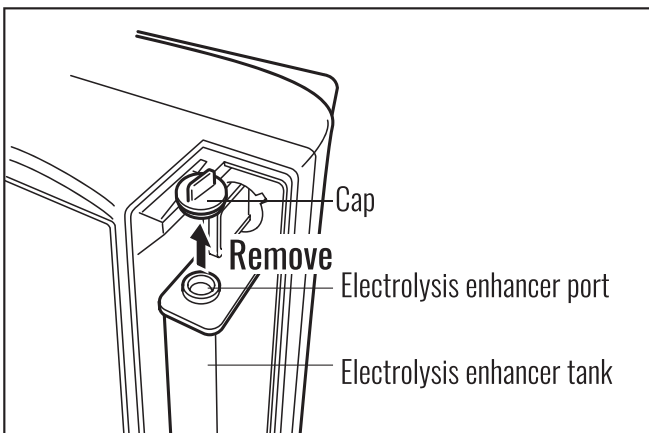

- ② Place the electrolysis enhancer into the tank from electrolysis enhancer port.

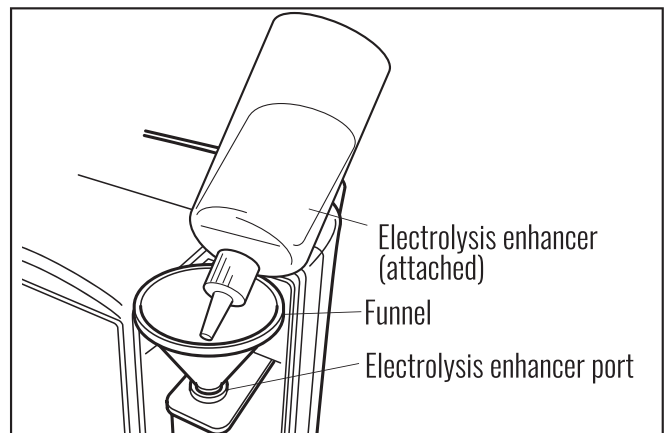

- ③ Replace the cap on the charging port and tighten it.

⚠️ ATTENTION

- After producing Strong Acidic Water, select another mode and continue to run the water until the cleaning mode stops. (about 30 seconds)
- Clean the electrolysis enhancer tank from time to time.

<How to clean electrolysis enhancer tank>

- ① Remove the tank cover and take out the electrolysis enhancer tank.

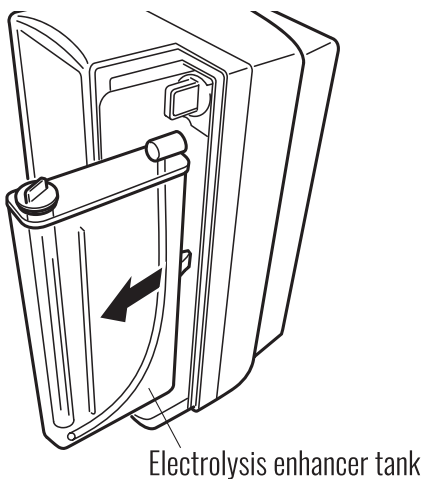

- ② Take off the cover from the electrolysis enhancer tank and clean the tank body.

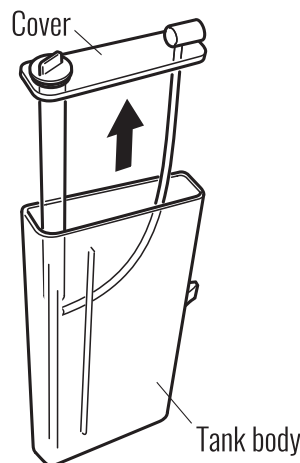

- ③ Replace the electrolysis enhancer tank in the original position and replace the cover.

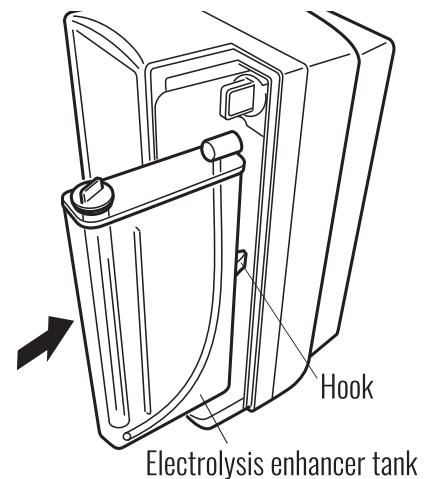

1

Press the **POWER** button to turn on the power.

> The POWER lamp come on.

The button sound + voice guidance

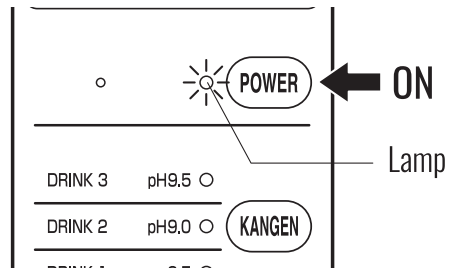

2

Press the **STRONG ACIDIC** button

> The STRONG ACIDIC lamp come on.

The button sound + voice guidance

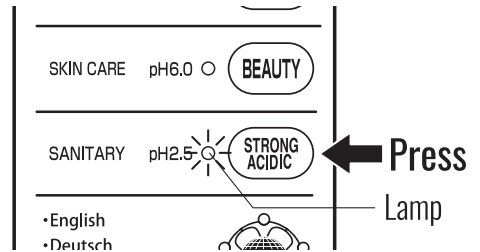

① Set the lever of the diverter to ION, turn on the water faucet to let the water flow.

ATTENTION

- When flow rate (pressure) is too low, a message will appear on the display and the voice guidance and alarm will become audible. (See P.13)
"Increase water flow"
- When you use enhancer fluid for the first time or after refilling the enhancer tank, the machine will display "RE-FILL SOLUTION" it will take about 20 seconds for the enhancer fluid to enter the electrolysis chamber.
- If the indication, "RE-FILL SOLUTION" does not go away in about 30 seconds lower the flow rate.

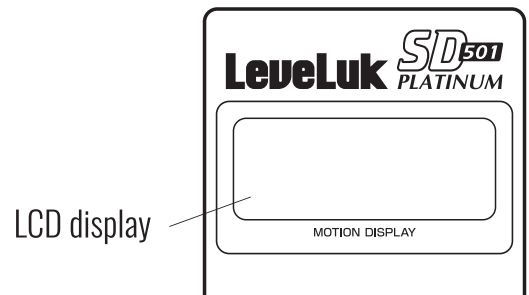
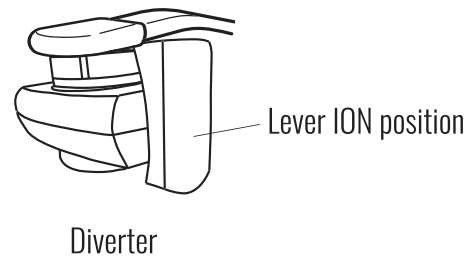

3

② Processed water will be discharged.

> STRONG ACIDIC Water is discharged from the secondary water hose and a beeping sound will be made when water is producing.

> STRONG KANGEN Water is discharged from the flexible pipe.

Voice guidance + Alarm sound

ATTENTION



- If the electrolysis enhancer is not enough, the voice guidance and alarm sound starts beeping and the message appears on the display. When this happens refill the electrolysis enhancer.
- After producing STRONG ACIDIC Water, select another mode and continue to run the water until the cleaning mode stops. (about 30 seconds)

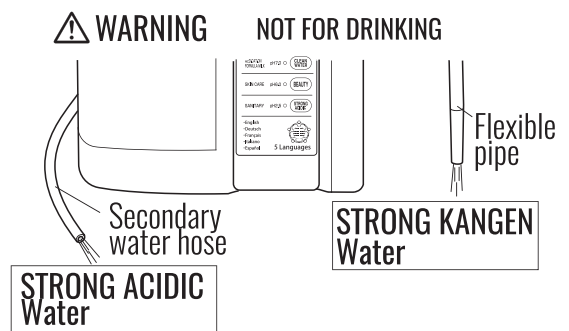



4	<div style="border: 1px solid black; padding: 5px; display: inline-block;">How to stop operation</div>
	Turn off the faucet to stop production of water. (If you wish to produce water continuously, follow step 3 of the operation procedure.)

How to measure pH value in STRONG ACIDIC Water

- Measure by book pH test paper (attached)



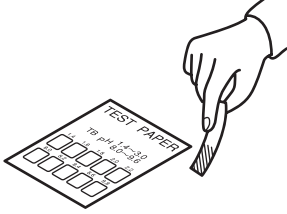



■ How to use book pH test paper

1	Carefully dip the pH test paper in the water sample (less than half a second). Then take it out immediately.	
2	Shake the pH test paper gently to remove excess water.	
3	Check the color of the wet portion of the paper to the standard color chart. Note: Color comparison and determination must be done in a brightly lit place.	

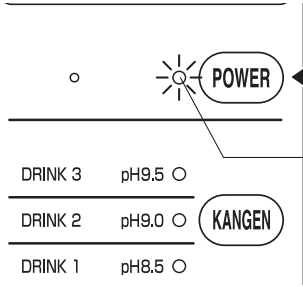
ATTENTION

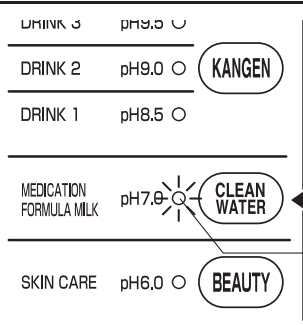
 Please observe	<ul style="list-style-type: none"> ▪ The pH test liquid (red) can not measure the pH 4.0 below. For measuring the pH value of STRONG ACIDIC Water, use the pH test paper. ▪ The pH test paper can only be used to check the pH value of STRONG ACIDIC Water. ▪ Do not lick the pH paper. If you do, rinse out your mouth and gargle immediately. ▪ Dipping the test paper too long (longer than 0.5 sec) causes the pigment to be dissolved into the sample water resulting in inaccurate test results. ▪ The consequence of leaving the pH test paper exposed to air for a long period of time may lead to inaccurate results. ▪ The sample water must be kept at room temperature in order to prevent pigment from diffusing too rapidly. ▪ The pH test paper may look different depending on storage conditions. This will not affect any of its properties or abilities. ▪ The pH test paper must be kept in cool, dry, and dark places. ▪ Store the pH testing liquid and paper out of reach of children.
--	---

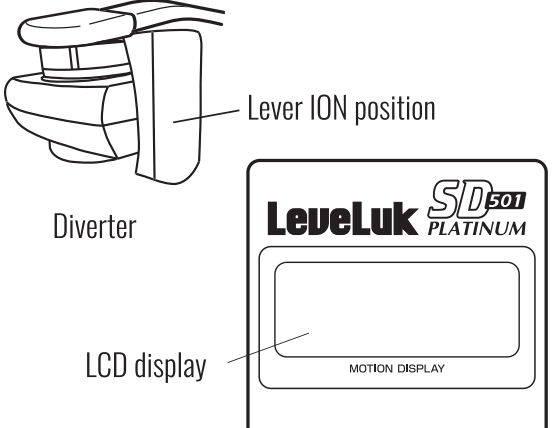
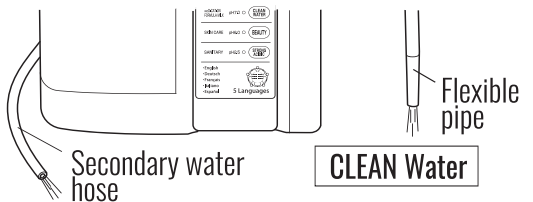
Producing CLEAN Water

<p>1</p>	<p>Press the POWER button to turn on the power.</p> <p>> The POWER lamp come on.</p> <p> The button sound + voice guidance</p>	 <p>POWER ON</p> <p>Lamp</p> <p>DRINK 3 pH9.5 ○</p> <p>DRINK 2 pH9.0 ○ KANGEN</p> <p>DRINK 1 pH8.5 ○</p>
<p>2</p>	<p>Press the CLEAN WATER button</p> <p>> The CLEAN WATER lamp come on.</p> <p> The button sound + voice guidance</p>	 <p>DRINK 3 pH9.5 ○</p> <p>DRINK 2 pH9.0 ○ KANGEN</p> <p>DRINK 1 pH8.5 ○</p> <p>MEDICATION FORMULA MILK pH7.8 ○ CLEAN WATER</p> <p>SKIN CARE pH6.0 ○ BEAUTY</p> <p>Press</p> <p>Lamp</p>
<p>3</p>	<p>① Set the lever of the diverter to ION. Turn on the water faucet to let the water flow.</p> <p>② Processed water will be discharged.</p> <p>> CLEAN Water is discharged from the flexible pipe.</p> <p> Voice guidance + Alarm sound</p> <p> ATTENTION</p> <ul style="list-style-type: none"> ▪ Use the Clean Water discharged from the flexible pipe. ▪ Do not use processed water while the LED is blinking. 	 <p>Lever ION position</p> <p>Diverter</p> <p>LCD display</p> <p>Leveluk SD501 PLATINUM</p> <p>MOTION DISPLAY</p>  <p>Secondary water hose</p> <p>CLEAN Water</p> <p>Flexible pipe</p> <p> WARNING</p> <p>NOT FOR DRINKING</p>
<p>4</p>	<p>How to stop operation</p> <p>Turn off the faucet to stop production of water. (If you wish to produce water continuously, follow step 3 of the operation procedure.)</p>	



Automatic Cleaning

ATTENTION



- Never drink water produced during automatic cleaning.
- While cleaning, let the water flow freely.

Calcium deposited on the electrodes in the electrolysis tank may result in degraded water. This unit automatically cleans the tank.

<p>1</p>	<p><Cleaning on></p> <p><Water running></p> <div style="border: 1px solid black; padding: 5px; text-align: center;"> <p>CLEANS</p> <p>> > > ></p> </div> <p>Beep, beep, beep</p> <p>LCD display</p> <p> Voice guidance + Alarm sound</p>	<ul style="list-style-type: none"> • When the unit produces KANGEN Water, Beauty Water or Strong Acidic Water, the time for use reaches 15 minutes, and then the unit will announce automatic cleaning. • Once the announcement of cleaning is made, the unit will start cleaning automatically for 30 seconds when the production of KANGEN, BEAUTY, STRONG ACIDIC or CLEAN WATER is taking place. <p> ATTENTION</p> <p>While the unit is producing the 4 kinds of water listed above, the unit will not switch over to the automatic cleaning mode.</p> <p>The unit will automatically clean the next time the unit is productive.</p>
<p>2</p>	<p><Message informing you that the unit is cleaning></p> <p><During stand by></p> <div style="border: 1px dashed black; padding: 5px; text-align: center;"> <p>NOTICE</p> <p>CLEANING</p> </div> <p>Water producing and cleaning modes alternately displayed</p> <p>LCD display</p> <p> Voice guidance</p>	<p>If cleaning is necessary at the beginning of the next production, the unit will issue a notification as referred on the left. The screen will display the type of processed water you have selected on the LCD and the cleaning mode alternately.</p>

• The unit cleans automatically in the following cases:

- ① The total operating time has reached 15 minutes. (After producing KANGEN Water, Beauty Water or Strong Acidic Water, the unit issues a notice of automatic cleaning and puts itself in standby mode. *Excluding Clean Water)
- ② After producing Strong Acidic Water, when producing KANGEN Water, Beauty Water or Clean Water.
- ③ When the unit is not used for 24 hours or more.

ATTENTION

- When disconnecting the power plug, please disconnect the power plug after turning off power switch.

3 Replacing the water filter (HG-N)

■ The water filter is a standard accessory that comes with a new unit.
 (Replacement activated charcoal water filters are available. Contact your local dealer.)

When the filter needs to be replaced, the unit issues a notification through voice guidance, alarm sounds and the LCD on the operation panel when the water supply is stopped.
 (The processed water selected and filter replace mode signals will alternately be displayed.)

1

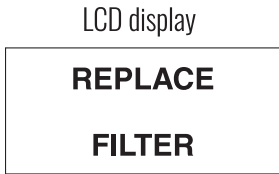

Voice guidance + Alarm sound

⚠ ATTENTION

- The "REPLACE FILTER" message does not appear while water is running.
- Replace the water filter after stopping the water.

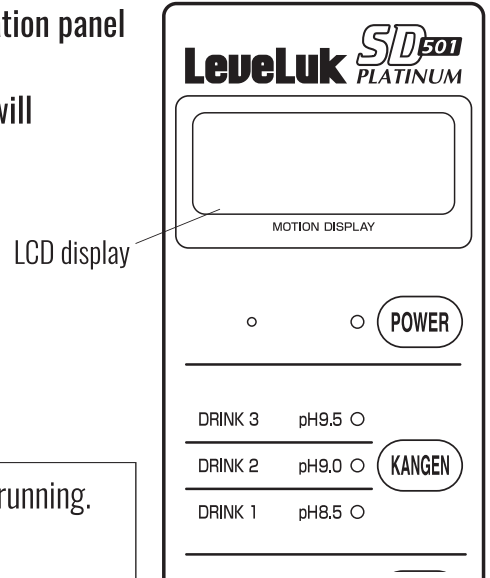

2 Push the water filter cover hook on the left side of the unit and remove the cover.

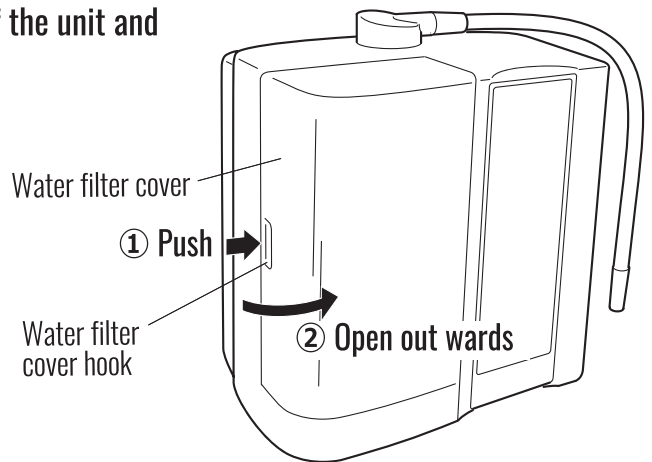

2

Turn the holder knob clockwise about 40 degrees to unlock the holder. Lift and take out the water filter.

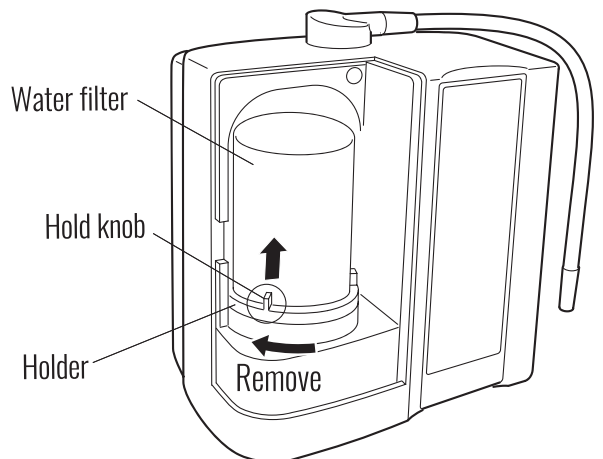

⚠ ATTENTION

- Be careful of water leaking out of the filter when removing the filter.

3

Ensure that the previous O-rings do not remain on the filter tray.
Confirm installation position and insert the replacement filter firmly.
Turn the water filter holder knob counter-clockwise about 40 degrees to secure and lock it.

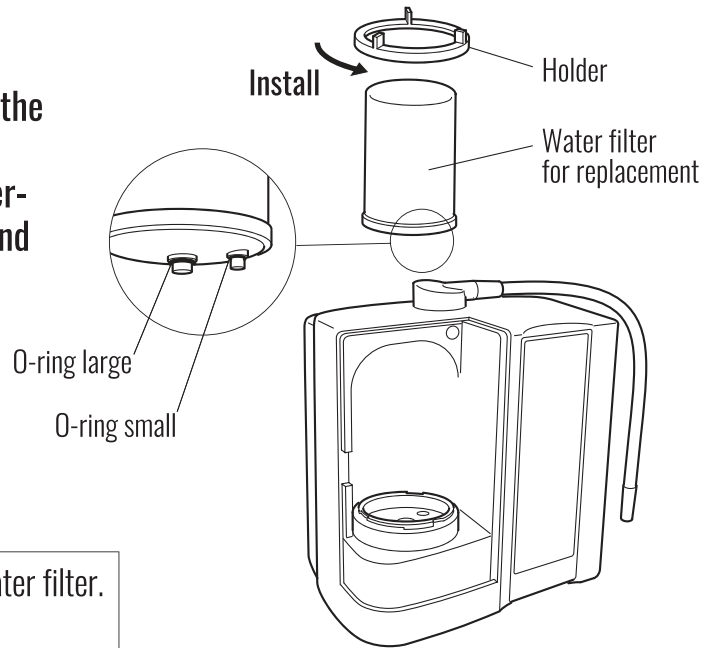

⚠ ATTENTION

- Check to see if 2 O-rings are fixed on the water filter.
- Check to see if the holder is inserted firmly.

4

Press the water filter reset switch.
The voice guidance and alarm (Beep) sound and a message "FILTER RESET" is displayed on the LCD.

 Voice guidance + Alarm sound



Replace the water filter cover.

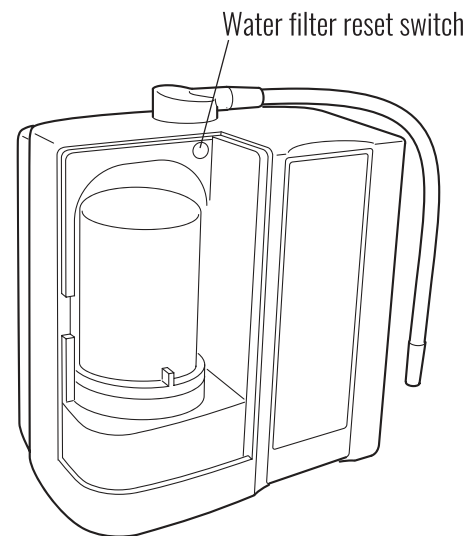

⚠ ATTENTION

- Be sure to use our genuine water filter for replacement. (Never use other manufactures' filters, as they may cause malfunction or other troubles.)
- Pour water into the device for 15 minutes when you use the device first or when you use the new water filter.
- Please ensure that the spent water filter (combustibles) observe the regulations of the region. (The material of water filter case is ABS resin. Please refer to page 35 standard specifications for inside filtering material.)

4 Troubleshooting

■ Use the following guide to self check your problems before contacting the company.

Trouble	Causes and measures to be taken
No power is supplied. (Power lamp does not come on)	<ul style="list-style-type: none"> ▪ Unit is not plugged the outlet. →Insert the power plug into the outlet.
Alarm sounds.	<ul style="list-style-type: none"> ▪ Defective condition present. →Follow the instruction on LCD display.
No water comes out. Output of all types of water is getting low.	<ul style="list-style-type: none"> ▪ The inside the unit is frozen. →Raise the room temperature and wait until it melts. ▪ Water flow (pressure) is low. →Open the faucet wider. ▪ Water filter was clogged. →Replace the water filter with a new one. ▪ Cleaning timing. →Clean using the E-Cleaner N. ▪ The hose is bent. →Smooth out the hose not to be bent.
Nasty odor or taste.	<ul style="list-style-type: none"> ▪ KANGEN Water pH concentration is too high. →Lower the pH concentration. ▪ Such odor or taste is coming from the water remaining inside. →Flow let the water for a while and completely drain the water inside the tank.
KANGEN Water has chlorine odor.	<ul style="list-style-type: none"> ▪ Water filter needs to be replaced. →Replace the water filter with a new one.
Whitish material is floating or has settled in KANGEN Water.	<ul style="list-style-type: none"> ▪ Calcium processed by electrolysis. →Change over to Beauty water and let the water flow for a few minutes. ▪ Cleaning timing. →Clean using the E-Cleaner N.
The inside of secondary water hose is stained dark.	<ul style="list-style-type: none"> ▪ Oxidizing material, such as iron has adhered. →Harmless.
Acidic Water does not go lower than pH2.7 when the Strong Acidic Water switch is selected.	<ul style="list-style-type: none"> ▪ Output of water is too high. →Reduce the water plug opening. ▪ No electrolysis enhancer. →Refill electrolysis enhancer.
Dropping pH value when processing KANGEN Water and Beauty Water.	<ul style="list-style-type: none"> ▪ Calcium buildup in the ionizing cell. →Press the BEAUTY button and run water for about 1 minute to clean the ionizing cell. ▪ Cleaning timing. →Clean using the E-Cleaner N.

⚠ ATTENTION

- Reactions of pH test liquid with ground water containing free carbonic acid.

In the event that ground or well water is used in place of tap water, because of the ionization of free carbonic acid in the water, the pH of KANGEN Water may return to neutral 1-2 seconds after electrolysis (the pH test liquid turns from blue to green). Despite this, KANGEN Water retains many of its characteristics, tastes good, and benefits.

- **Test method** : Put 3 or 4 drops of the pH test liquid in an empty transparent glass. Pour KANGEN Water (pH 9.5) in the glass.
- **Reactions** : The solution turns somewhere between royal purple and blue just after adding the KANGEN Water and from blue to green in 1-2 seconds.

Cleaning with the E-Cleaner N

Cleaning Powder Unit (CPU-N)
(Replace when CPU-N is broken.)

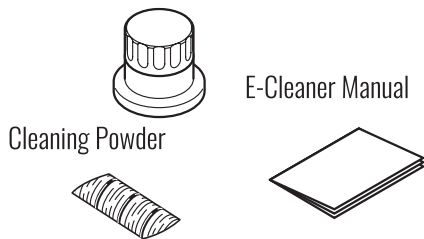

⚠ **ATTENTION** Please use the cleaning powder once every week or two weeks.

- *Be sure to shut off the faucet* and turn off the unit before cleaning.
- Always turn the power off and disconnect the plug.
- Please only use one pack of the cleaning powder fabricated by the manufacturer for each individual treatment. Using another cleaning powder could cause internal damage to the unit.

The cleaning powder includes citric acid so avoid using the water during cleaning mode to sanitize all fruits and vegetables.

Cleaning machine

- Use E-Cleaner N once every week to two weeks. -

We recommend deep cleaning once a year at a qualified service center. Deep cleaning intervals may vary, depending on hardness of source water. Water softener is recommended only for extremely hard water sources.

- ① Unscrew the cap of the CPU-N (Cleaning Powder Unit) pour the cleaning powder evenly into the bottom, and retighten the cap.

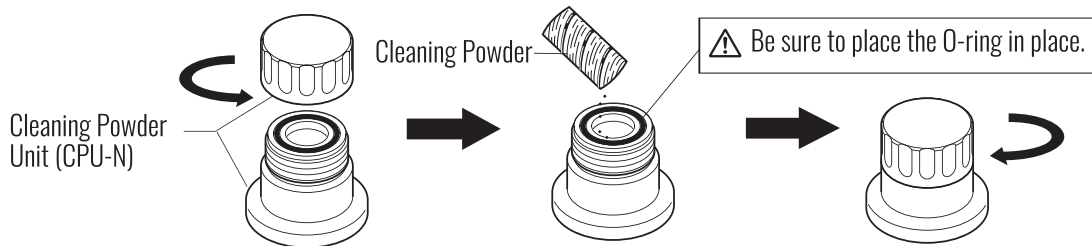

- ② After turning off the water faucet, remove the filter cover from the main unit rotate the holder and remove the water filter.

⚠ Always turn the power off and disconnect the plug.

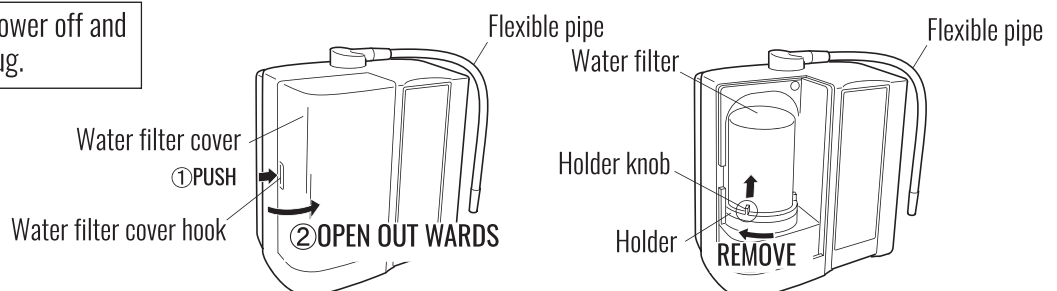

- ③ Place the cleaning powder unit on the main unit, and secure the unit in place with the holder.

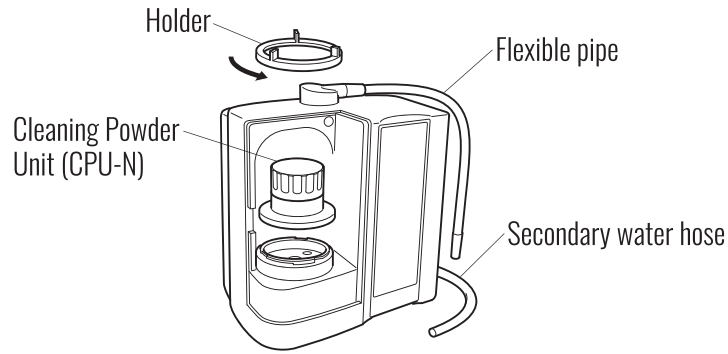

- ④ Turn on the faucet to allow the water to flow through the flexible pipe for approximately 10 seconds (approx. 1 liter), then turn off the water.

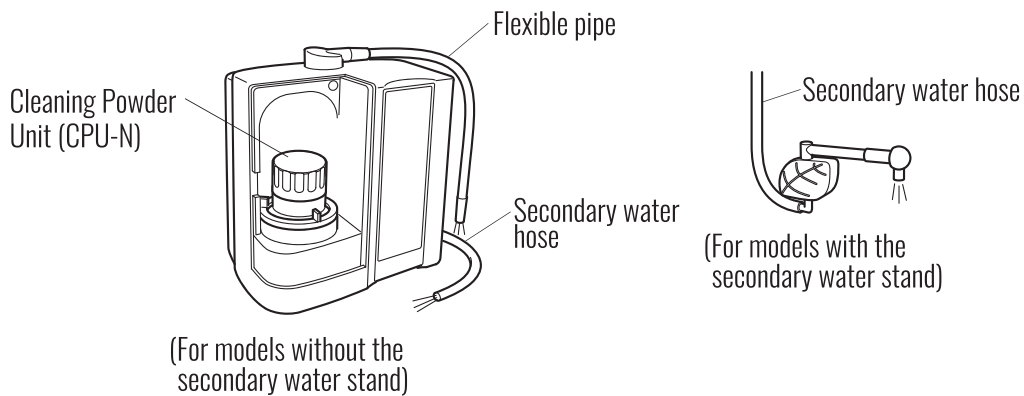

- ⑤ Place the tip of the flexible pipe and secondary water hose/secondary water stand at the bottom of a cup, and allow the water to flow through the pipe until the cup is half-full of water. Turn off the faucet, and leave the pipe and hose in the cup for three to five hours.

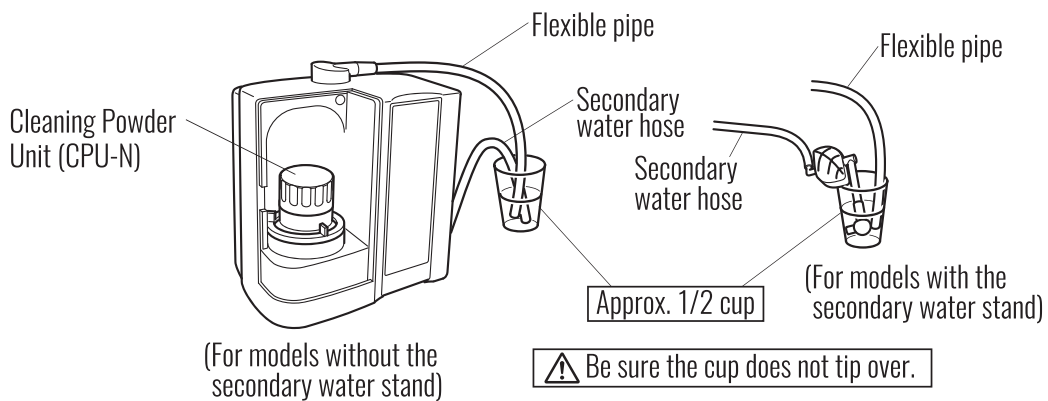

- ⑥ Remove the cup after three to five hours. Turn on the faucet and allow water to flow through for several minutes.

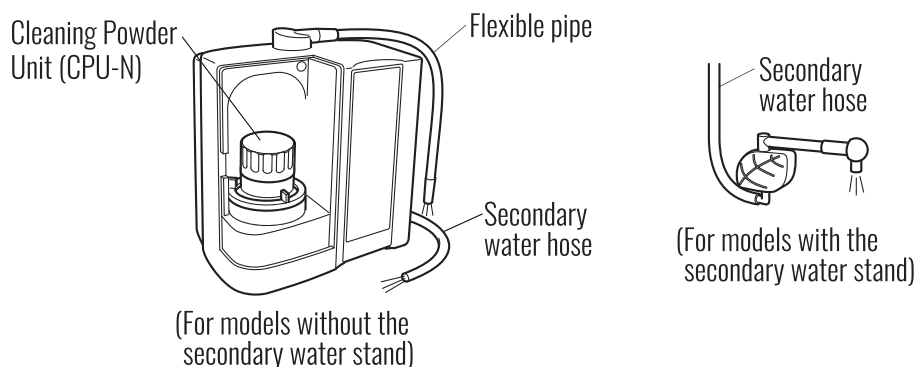

- ⑦ **Turn off the faucet, and then replace the water filter that was removed in step 2.**
Turn on the faucet and allow water to flow through for several minutes.

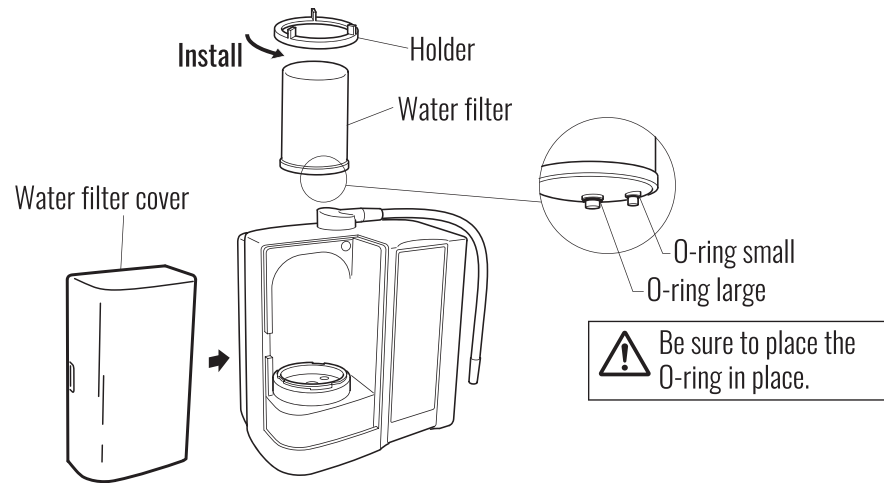

- ⑧ **Reattach the filter cover and plug in the electrical cord. The cleaning process is now complete.**
- ⑨ **After completing the cleaning process, deposits may flow out for a while during use.**
Discard the water if deposits are found in it.
- ⑩ **After using the CPU-N, rinse the unit with tap water thoroughly, and dry it off completely with a soft cloth and store the unit in a dry place.**
- ⑪ **If the O-ring or the cap is damaged, replace it immediately.**
The CPU-N is a consumable item. Please purchase a new one on a regular basis.

5 Options

• Options

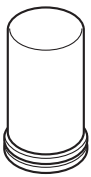

① Water filter for replacement Activated charcoal type HG-N



② Electrolysis enhancer



③ Glycerophosphoric acid calcium (3 g each)

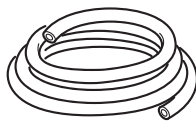

④ Water supply hose (1-5 m)

⑤ Secondary water hose (1-5 m)

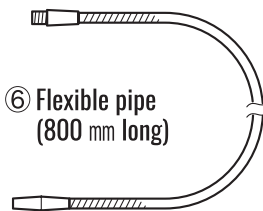

⑥ Flexible pipe (800 mm long)

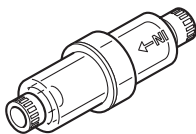

⑦ Pre-filter



⑧ Chlorine reagent (15 ml) (residual chlorine measuring reagent) USA only

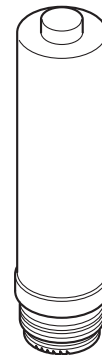

⑨ DPS Replacement Filter

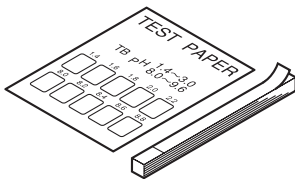

⑩ Book pH test paper



⑪ pH test liquid



⑫ Test tube

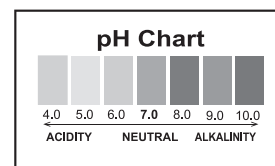

⑬ pH color comparison table

pH test liquid goods

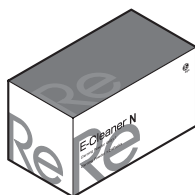

⑭ E-Cleaner N
Cleaning powder Unit (CPU-N)
Cleaning powder (24 pcs)



⑮ Cleaning powder (24 pcs.)

6 Standard specifications

Item name		LeveLuk SD501 PLATINUM		
Feed water specs and connection		ONE way diverter		
Power supply Rated current		(USA) 120 V AC 60 Hz 3.2 A (Europe / parts of Asia) 220–240 V AC 50–60 Hz 1.6 A		
Power consumption		Max. approx. 230 W (If production is done at a high KANGEN pH level)		
Main unit	Dimensions	13.3 ^(H) × 10.4 ^(W) × 6.7 ^(D) inch / 338 ^(H) × 264 ^(W) × 171 ^(D) mm		
	Weight	Approx. 13.9 lbs / 6.3 kg		
Ionizing system		Continuous ionizing system (Built-in flow rate sensor)		
Electrolysis	KANGEN Water	0.7–1.1 gal/min 2.5–4.0 L/min		
	Feed water pressure Approx.	14.5 psi / 100kPa		
	Strong Acidic Water	0.2–0.3 gal/min 0.6–1.2 L/min		
	Feed water pressure Approx.	15 psi / 100kPa		
	Electrolysis capacity settings	7 levels	KANGEN Water at 3 levels (Approx.pH8.5/pH9.0/pH9.5) Clean Water (Approx.pH7.0) Beauty Water (Approx.pH6.0) Strong Acidic Water (Approx.pH2.5) Strong KANGEN Water (Approx.pH11.0)	
	Cleaning system of ionizing cell	Automatic cleaning system		
	Materials of electrode and ionizing cell	Platinum-plated titanium		
Water filter	Filter material	Granulated antibacterial activated charcoal, calcium sulfite		
	Removable substance	Aesthetic Chlorine,Taste and Odor up to 1500 gallons		
	Un-removable substance	Metal ions/salt dissolved in original tap water		
	Replacement interval	Varies according to region and water quality		
Applicable water pressure		7 psi–65 psi / 50kPa–450kPa (Approx.0.5 kgf/cm ² –4.5 kgf/cm ²)		
Available water temperature		41–95°F / 5–35°C		
Electrolysis enhancer (for Strong Acidic Water production)		Forced dissolving adding type		
Electrolysis enhancer (sodium chloride) re-fill need indication		Voice guidance, Alarm sound, LCD message		
Protective device		120 V AC 60 HzCurrent fuse 6 A / 220–240 V AC 50–60 HzCurrent fuse 3 A		
Detective device		Detection of temperature rise and hot water		
Length of power cord		Approx. 1.5 m		

- Specifications and design subject to change for product improvements without notice.
- The electrolytic processing capacity and the filter service life largely depend on the water quality or how the machine was used.

After-sales Service

Warranty

- Please keep the included warranty in a safe place for future reference.

If you need repair during warranty period

- For repairs, please contact your local dealer.
(Please read the warranty carefully, some repairs may not be covered under the warranty.)

⚠ ATTENTION *You may be charged if your repair is for any of the following reasons.

1. Trouble resulting from handling in a manner that is not specified in the "Operation Manual".
2. Trouble or damage due to the use of water other than municipal drinking water.
3. Trouble or damage due to natural disaster, such as, earthquake, fires or floods.
4. Dropping the product or damage caused during transportation.
5. Damage caused by use of improper voltage.
6. Replacement of consumable parts.
7. Replacement of spent electrode.
8. Trouble resulting from improper usage or failure to perform regular maintenance.
9. Trouble resulting from tampering or altering.
10. Trouble caused by sediment or lime scale deposits.

If you need repair after warranty expiration

- Contact your local dealer. Repair may be available upon request at purchaser's expense.

Others

- If you have any questions about the product, please contact your dealer.
- For use with cold water only.
- Do not use with water that is microbiologically unsafe or of unknown quality without adequate disinfection before or after the system.
- Water pipe connections and fixtures directly connected to a potable water supply shall be sized, installed, and maintained in accordance with federal, state, and local codes.

⚠ WARNING



In no case should the product be modified, overhauled or repaired by purchaser, as fire or electrical shock could result. Any consequences of such behavior shall not be compensated by the maker.

- For questions and information, please contact your local dealer.

Los Angeles :

TEL. +1-310-542-7700 FAX. +1-310-542-1700

New York :

TEL. +1-718-784-2110 FAX. +1-718-784-2103

Chicago :

TEL. +1-847-430-4013 FAX. +1-847-437-8201

Honolulu :

TEL. +1-808-949-5300 FAX. +1-808-949-5336

Texas :

TEL. +1-972-316-7985 FAX. +1-310-531-7111

Seattle :

TEL. +1-425-640-2222 FAX. +1-425-672-8946

Orlando :

TEL. +1-407-601-5963 FAX. +1-407-630-6081

Burnaby :

TEL. +1-604-214-0065 FAX. +1-604-214-0067

Toronto :

TEL. +1-905-507-1200 FAX. +1-416-445-6594

Mexico :

TEL. +52-81-8242-5500 FAX. +52-81-8242-5549

Brazil :

TEL. +55-15-3034-4132 FAX. +55-15-3034-4100

Germany :

TEL. +49-211-936570-00 FAX. +49-211-936570-27

France :

TEL. +33 (0) 1 47 07 55 65 FAX. +33 (0) 1 83 71 17 06

Italy :

TEL. +39-6-3330-670 FAX. +39-6-3321-9505

Australia :

TEL. +61-2-9878-1100 FAX. +61-2-9878-1200

Russia :

TEL. +7-495-988-02-05 FAX. +7-495-988-02-06

Romania :

TEL. +40-374028779

Portugal :

TEL. +351-22-8305464

Hong Kong :

TEL. +852-2154-0077 FAX. +852-2154-0027

Dubai :

TEL. +971 4 395 5011 FAX. +971 4 395 5150

Taiwan :

TEL. +886-2-2713-2936 FAX. +886-2-2713-2938

Philippines :

TEL. +63-2-519-5508 FAX. +63-2-519-1923

Korea(Seoul) :

TEL. +82-2-546-8120 FAX. +82-2-546-8127

Korea(Busan) :

TEL. +82-51-744-8822 FAX. +82-51-744-8833

Singapore :

TEL. +65-6720-7501 FAX. +65-6720-7505

Malaysia :

TEL. +60-3-2282-2332 FAX. +60-3-2282-2335

Indonesia :

TEL. +62-21-2992-3111 FAX. +62-21-2992-8111

Thailand :

TEL. +66-2-163-2869 FAX. +66-2-163-2879

India :

TEL. +91-80-4650-9900 FAX. +91-80-4650-9908

Mongolia :

TEL. +976-7012-7778 FAX. +976-7012-7708

Tokyo :

TEL. +81-3-5205-6030 FAX. +81-3-5205-6035

Sapporo :

TEL. +81-11-223-5678 FAX. +81-11-223-5680

Nago :

TEL. +81-980-51-0616 FAX. +81-980-51-0628

Shin-Osaka :

TEL. +81-6-6152-5407 FAX. +81-6-6152-5408

Fukuoka

TEL. +81-92-741-4132 FAX. +81-92-741-4133

Osaka Factory :

TEL. +81-72-893-2290 FAX. +81-72-893-8007